

LANG

SWITZERLAND



TheWell

TheWell ver5 - User Manual 1.0

Operations Guide **Safety Precautions**



CAUTION: WHEN YOU SEE THIS SIGN, PLEASE REFER

TO THE SAFETY PRECAUTIONS TO AVOID HARM AND DAMAGE.

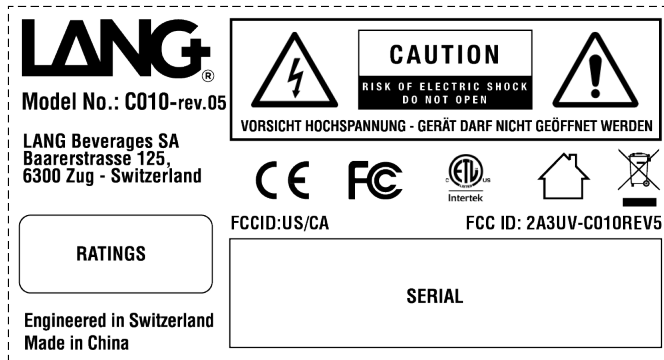

ASSISTANCE VIDEOS AN FAQ SECTION ARE AVAILABLE AT WWW.DRINKLANG.COM VISIT "SUPPORT" SECTION

This device complies with Part 15 of the FCC Rules. Operation is subject to the following two conditions: (1) this device may not cause harmful interference, and (2) this device must accept any interference received, including interference that may cause undesired operation.

Changes or modifications to this unit not expressly approved by Lang Beverages sa could void the user's authority to operate the equipment.

NOTE: This equipment has been tested and found to comply with the limits for a Class B digital device, pursuant to Part 15 of the FCC Rules.

These limits are designed to provide reasonable protection against harmful interference in a residential installation.

This equipment generates uses and can radiate radio frequency energy and, if not installed and used in accordance with the instructions, may cause harmful interference to radio communications.

However, there is no guarantee that interference will not occur in a particular installation. If this equipment does cause harmful interference to radio or television reception, which can be determined by turning the equipment off and on, the user is encouraged to try to correct the interference by one or more of the following measures:

- Reorient or relocate the receiving antenna.
- Increase the separation between the equipment and receiver.
- Connect the equipment into an outlet on a circuit different from that to which the receiver is connected.
- Consult the dealer or an experienced radio/TV technician for help.

Changes or modifications to this product not authorized by Lang Beverages sa may void compliance with electromagnetic compatibility (EMC) and wireless standards, as well as the authorization to use the product.

These instructions are part of the appliance. Read all instructions and safety instructions before operating the appliance.

When using electrical appliances, basic important safeguards should always be followed, including the following:

- Read all instructions.
- Do not use outdoors.
- Do not let cord hang over edge of table or counter, or touch hot surfaces.
- The appliance is intended to prepare beverages according to these instructions.
- This appliance should only be used for intended purpose.
- This appliance is only meant for indoor use, under non-extreme temperature conditions.
- The appliance must not be used, cleaned, or maintained by children under 8 years of age unless supervised, instructed by an adult on how to use the appliance safely, and fully informed regarding the dangers involved.
- Close supervision is necessary when any appliance is used near children.
- Keep appliance / power cord / LANGPAK out of reach of children.
- Children should not use the appliance.
- This appliance may be used by persons with reduced physical, sensory or mental capabilities, or whose experience or knowledge is not sufficient, provided they are supervised, or has received instruction to use the device safely and understand the dangers.
- Any servicing other than cleaning and user maintenance should be performed by an author-

ized service representative.

Avoid risk of fatal electrical shock and fire to protect against fire, electric shock and injury to persons

- If the cord or the plug are damaged, they must be replaced by the manufacturer, its service agent or similarly qualified persons.
- If the cord or the plug are damaged, do not operate the appliance.
- To disconnect, turn the appliance "OFF", then remove the plug from the outlet.
- To avoid hazardous damage, never place the appliance on or beside hot surfaces such as radiators, stoves, ovens, gas burners, open flames, or similar.
- Disconnect from outlet before cleaning.
- Never immerse the cord, plug, appliance or any part of it in water or any other liquid.
- Electricity and water together are dangerous and can lead to fatal electric shocks.
- Do not put anything else than specified LANGPAK containers and filter cartridges into the appliance. Doing so may cause fire or electric shock!
- The use of accessory attachments not recommended by the appliance manufacturer may result in fire, electric shock, or injury.

Avoid possible harm when operating the appliance.

- Risk of scalding by hot liquids. If the machine is forced open hot liquids may splash. Never open it during operation.

SAVE THESE INSTRUCTIONS

This Instruction Manual is also available as a PDF file at www.drinklang.com

OTHER SAFEGUARDS

When using electrical appliances, important safeguards should always be followed, including the following:

- The important safeguards are part of the appliance. Read the important safeguards provided with the appliance carefully prior to first use. Keep them in a place where you can find and refer to them in the future.
- Protect the appliance from direct sunlight, water splash and humidity.
- This appliance is designed for domestic use only.
- Close supervision is necessary when the appliance is used by or near children.
- Children shall not play with the appliance.
- The manufacturer accepts no responsibility for and the warranty will not apply to any commercial use, inappropriate handling or use of the appliance, damage resulting from use for other purposes, faulty operation, non-professional repairs or failure to comply with the instructions.

Avoid risk of fatal electrical shock and fire to protect against fire, electric shock and injury to persons.

- In case of emergency: immediately remove the plug from the power outlet.
- Only plug the appliance into suitable, easily accessible, grounded outlets. Make sure that the voltage of the power source is the same as that specified on the rating plate. The use of

an incorrect voltage or frequency of electricity voids the warranty.

- Do not pull the cord over sharp edges, clamp it or allow it to hang down.
- Keep the cord away from heat and moisture.

Always place the appliance on a horizontal, stable, hard, even surface that does not allow for water accumulation under the appliance.

- The surface must be resistant to heat and fluids, like water, tea, descaler or similar.
- Disconnect the appliance from the power outlet when not in use for a long period of time.
- Disconnect by pulling out the plug; do not pull on the cord itself to avoid damage.
- Never touch the cord with wet hands.
- Never put the appliance in a dishwasher.
- Do not open the appliance. Hazardous voltage inside!
- Do not dismantle the appliance.

Avoid possible harm when operating the appliance

- Never leave the appliance unattended during operation.
- Do not use the appliance if it is damaged or not operating perfectly. Immediately remove the plug from the power outlet. Contact the Lang Beverages authorized representative for examination, repair or adjustment. A damaged appliance can cause electric shocks, burns and fire.
- Do not put fingers under water outlet; risk of scalding.
- Beware of hot liquids.
- Never use a damaged or deformed LANGPAK.
- Always completely empty the tap water jar before refilling with fresh tap water.
- Do not use any other liquids than water (such as cow's milk, soya milk, enriched milks, flavored liquids, etc.).
- Do not overfill tap water jar.
- Empty the jars if the appliance will not be used for an extended time (holidays, etc.).
- Do not use the appliance without a bottle, jar, glass or cup placed on the clean water docking station.
- Do not use any strong cleaning agent or solvent cleaner.
- Use a damp cloth and mild cleaning agent to clean the surface of the appliance.
- Do not use a steam or pressure cleaner to clean the appliance. This will damage the appliance and may create a life-threatening hazard.
- Do not pour water or other liquids into the LANGPAK compartment.
- Keep appliance, LANGPAK containers and accessories out of reach of children.
- This appliance is designed for LANGPAK containers exclusively.
- All Lang Beverages appliances pass stringent controls. Reliability tests under practical conditions are randomly performed on selected units. Some units can therefore show traces of previous use.
- Lang Beverages reserves the right to change instructions without prior notice.

WARNING! LANG purified mineralized water and flavored beverages are fresh produce and do not contain any preservatives. Consume the same day of processing if kept in room temperature, or within 3 days if stored cold (less than +8C / +46F).

SHORT CORD INSTRUCTIONS

- Use the power cord supplied with the device in an unmodified form. It is important for user safety that the appliance is only used with a suitably grounded electrical supply.
- a) A short power supply cord or detachable power supply cord is to be provided to reduce risks resulting from becoming entangled in or tripping over a longer cord.
- b) Extension cords are available and may be used if care is exercised in their use.
- c) If a long detachable power cord or extension cord is used:
 - 1) The marked electrical rating or the detachable power cord or extension should be at least as great as the electrical rating of the appliance.
 - 2) The appliance is grounded and only grounded extension cord should be used (type 3-wire cord).
 - 3) The longer cord should be arranged so that it will not dangle over the countertop or tabletop, where it can be pulled on by children or tripped over.
- The appliance has a grounded plug.
- To reduce the risk of electric shock, this plug is intended to fit into a grounded outlet only one way.
- If the plug does not fit fully into the outlet, reverse the plug.
- If it still does not fit, contact a qualified electrician.
- Do not attempt to modify the plug in any way.

DESCALING

Lang Beverages descaling agent, when used correctly, helps to ensure the proper functioning of your appliance over its life-time and that your drinking experience is as perfect as on the first day. For instructions on how to descale, consult the section “Descaling” in the user manual.

LANG BEVERAGES SA
BAARERSTRASSE 125,
6300 ZUG
SWITZERLAND

MADE IN CHINA

Index TheWell V5

1. OVERVIEW	6
1.1 Components	
1.2 Control Panel	
2. STARTUP GUIDE	8
2.1 Installing the filters	
2.2 Inserting the langpak containers (minerals and flavors)	
2.3 Connecting the power	
2.4 Installing the jars	
2.5 Selecting the language	
2.6 Setting the date	
2.7 Setting up the filters	
2.8 Hot cleaning	
3. NORMAL OPERATION	19
3.1 Cup mode/normal mode	
3.2 Cold, hot & flavored water processing	
3.3 Consuming langwater & langwater+	
3.4 Energy saving mode	
4. MENU OPTIONS	22
4.1 Customize	
4.2 Maintenance menu options	
4.3 Setup menu	
5. MAINTENANCE	34
5.1 Cleaning	
5.2 Drip tray	
5.3 Automated maintenance cycles	
5.4 Hot cleaning	
5.5 Changing the filters	
5.6 Descaling	
5.7 Filter rinsing	
6. TROUBLESHOOTING	45
7. PRODUCT INFORMATION	52

1. OVERVIEW

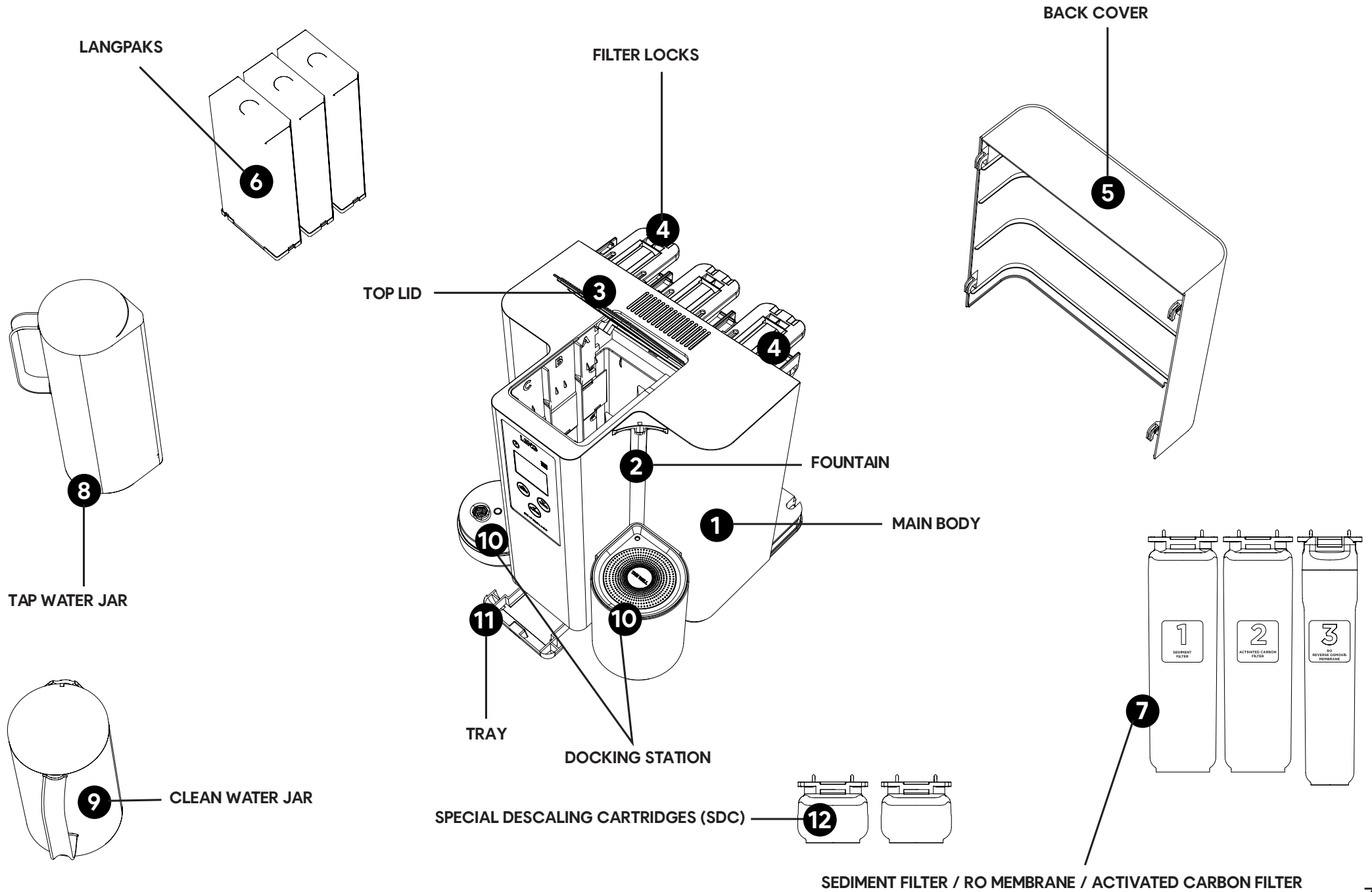

1.1 COMPONENTS

This package contains TheWell beverage system with the following accessories:

1 x Tap Water Jar With Lid

1 x Clean Water Jar With Lid

3 x Filter Cartridges (Sediment, Activated Carbon, RO Membrane).

1 x Power Cord

2 x Special Descaling Cartridges (SDC)

1.2 CONTROL PANEL

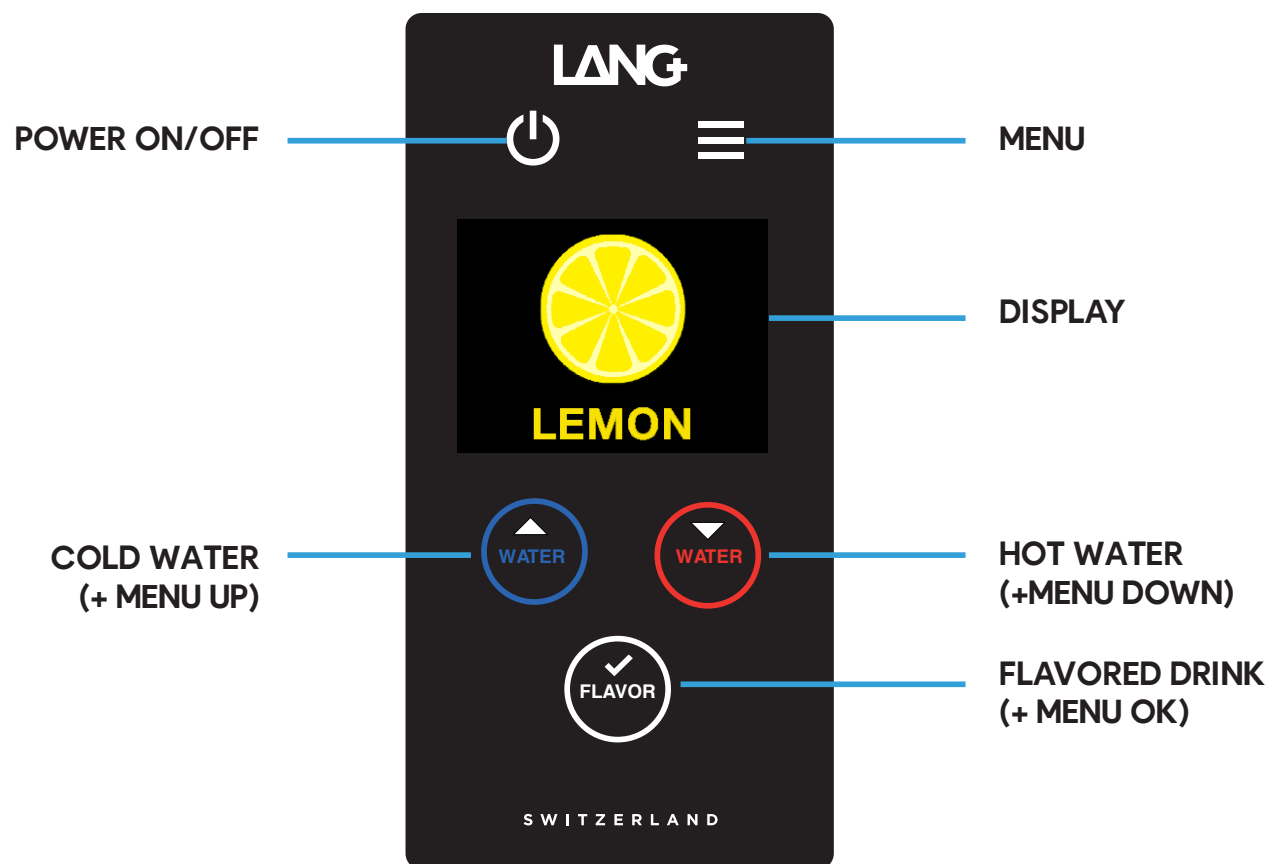

2. START-UP GUIDE

Before using TheWell for the first time, you'll need to complete the Setup Process, which takes about xx minutes. TheWell's display will guide you through the steps, and the following section explains them in detail.

2.1. INSTALLING THE FILTERS

The system has three filters. All three are required for operation.

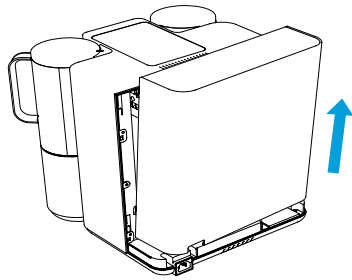

Open the rear cover. Lift up to unlock hooks.

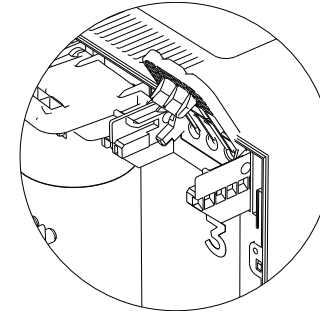

Push the levers up to install filter cartridges.

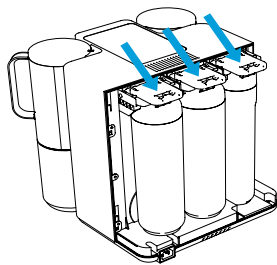

Install the three filter cartridges.

1. Sediment Filter
2. Activated Carbon
3. RO Membrane

When done, push each lever down until it locks.

Make sure the levers are tightly locked to avoid water spray or leakage.

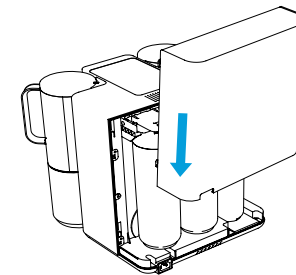

Re-install the rear housing cover.

2.2. INSERTING THE LANGPAK CONTAINERS (MINERALS AND FLAVOR)

The system has three LANGPAK slots. Two containers are required (Mineral A and Mineral B) and one is optional (flavor).

To open the top lid, press gently on the back part of the lid.

Install LANGPAK Mineral A in the slot marked "A".

Install LANGPAK Mineral B in the slot marked "B".

IMPORTANT: TheWell machine will only operate when both Mineral A and Mineral B containers are inserted. TheWell will also detect when the mineral containers are empty and will stop operating until they are replaced.

Optional: install a LANGWATER+ flavor container in the slot marked "C".

IMPORTANT: Push the containers down until they lock firmly in position.

Close the top lid after minerals and flavor containers are installed.

IMPORTANT: If the top lid does not close completely, it means that one or more of the LANGPAK containers is not properly inserted. Remove and reinsert the containers, pushing them down firmly so they lock.

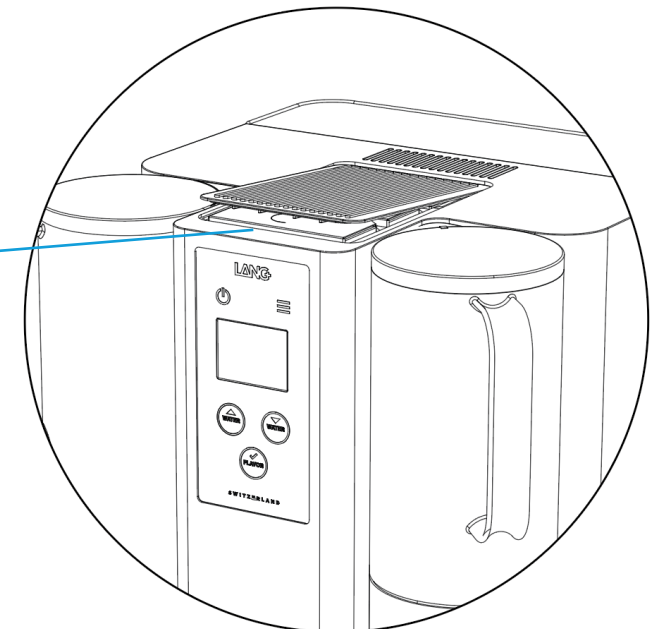
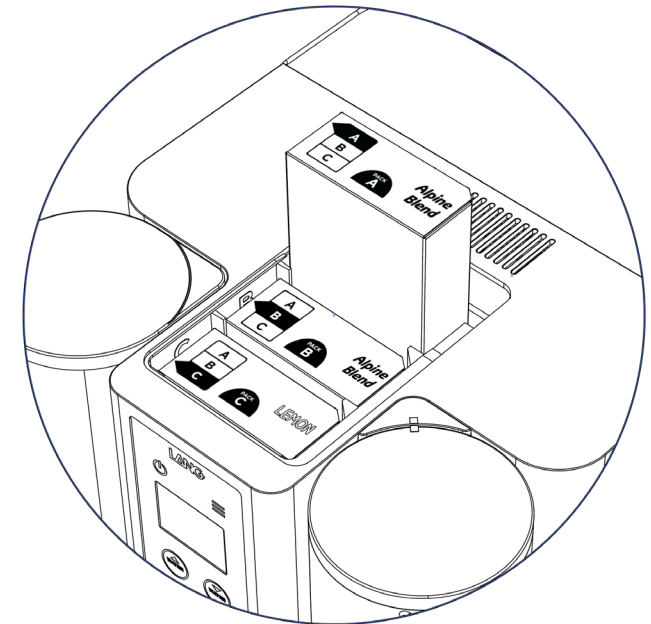

2.3 CONNECTING THE POWER

Connect the power cord.
The machine will now turn on and display the language selection menu.

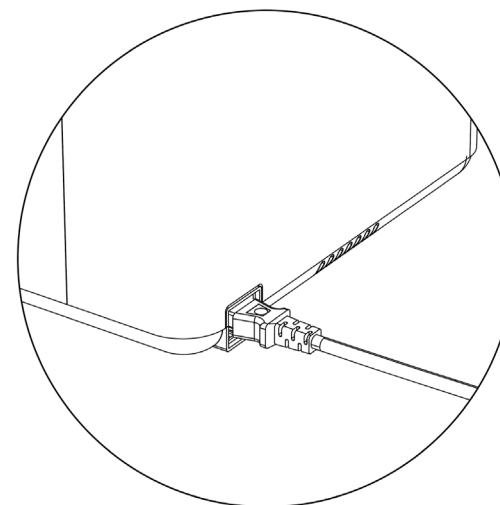

2.4 INSTALLING THE JARS

There are two jars: A Tap Water Jar and a Clean Water Jar.

1. Fill the Tap Water Jar with water, almost all the way to the top. Attach the lid.
Set the Tap Water Jar in the left docking station.
Place the tap water jar on the left docking station.

IMPORTANT: Be sure that the jar is straight and firmly in position. Otherwise, water may leak.

2. Set the empty Clean Water Jar in the right docking station.
Attach the lid.

IMPORTANT: ROTATE THE JAR LID UNTIL THE SQUARE DOTS ON THE LID AND THE MACHINE ARE ALIGNED.

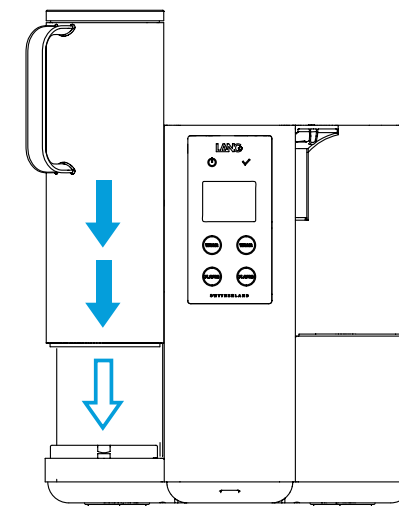
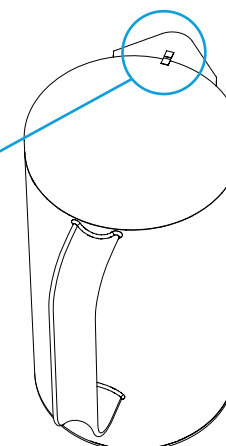

2.5 SELECTING THE LANGUAGE

Select the language by using the up  and down arrows .

Confirm and save your selection by pressing the button  beneath them.



2.6 SETTING THE DATE

Set the current date. Use up  and down  arrows to change the value for day, month, and year. Press OK  to cycle through the day, month, and year.

Press Menu  to save the date.

Setting the date allows the system to keep track of schedules for cleaning and filter replacement.

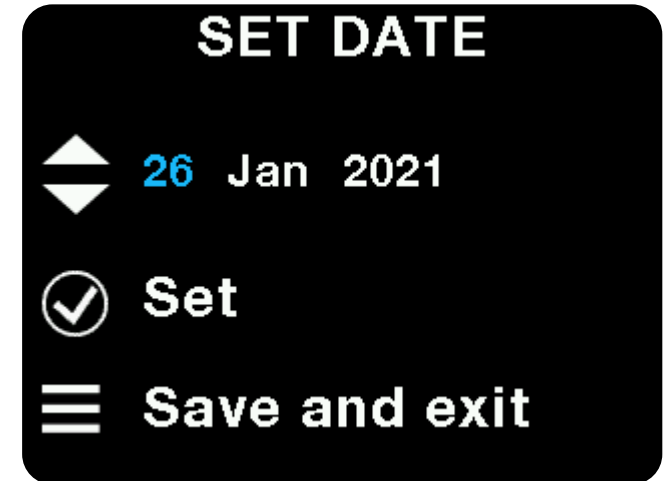

2.7 SETTING UP THE FILTERS

When new filters are inserted in the appliance, they need to be filled and rinsed before they can be used to process water. Since TheWell comes with new filters, this filter change procedure is required to set it up and takes about 30 minutes. The procedure is automated, but it requires that the user be available to fill the Tap Water Jar with clean water and empty the Clean Water Jar when it is full. This will be required several times during the procedure.

The machine will display a warning message when filters are due for replacement, every two years.

WARNING! DO NOT DRINK THE WATER THAT IS PROCESSED DURING THE CHANGE FILTER PROCESS, SINCE THIS IS ALSO A CLEANING PROCESS.

Insert all three new filter cartridges as described in Section 2.1 above.
Make sure the filters are properly seated, the levers are locked, and the rear cover is in place.

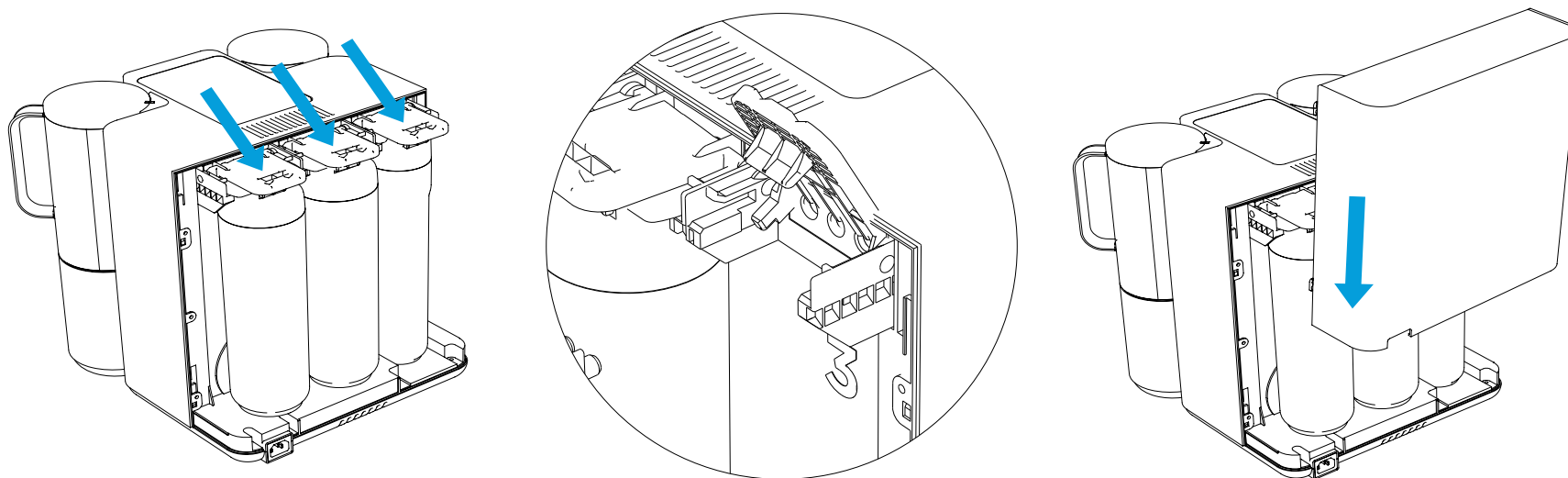
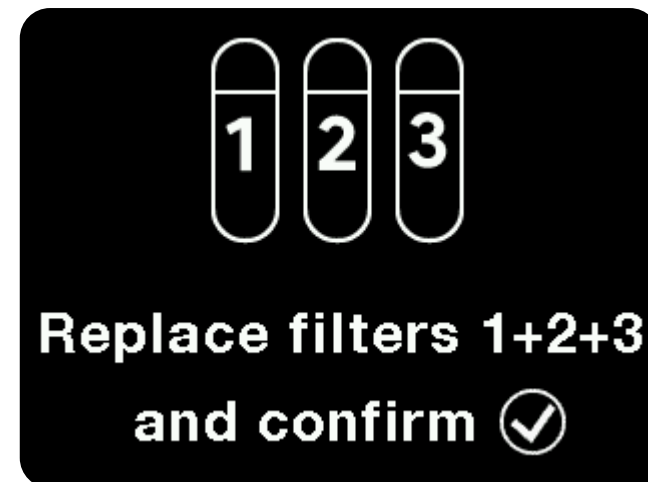

Once the filters are correctly inserted, press OK  to continue.

The machine will now instruct the user to empty and refill the Tap Water Jar. Make sure the Tap Water Jar is filled with fresh water and correctly placed in the left docking station.

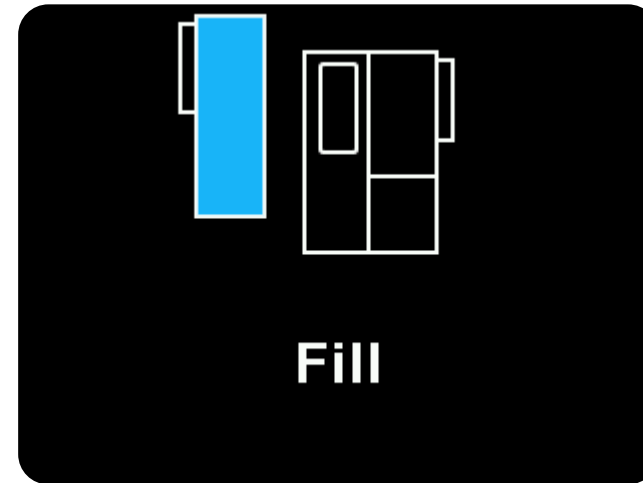
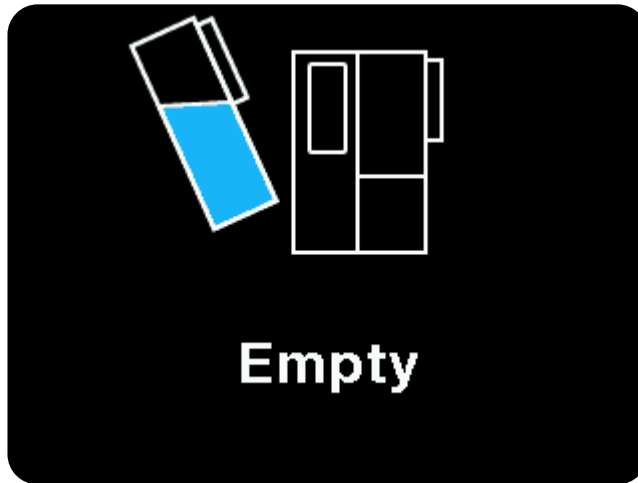

The machine will now instruct the user to empty the Clean Water Jar and place it in the right

docking station. Once it is correctly inserted, press OK  to continue.

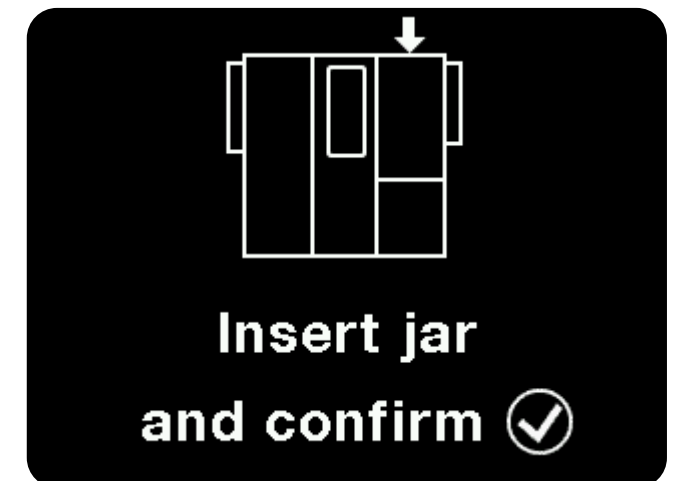

The machine will now start running water through the new filters. 4.5 liters of water (3 full Clean Water Jars) will need to be processed before the procedure is finished.

During this process, when the Tap Water Jar becomes empty or the Clean Water Jar becomes full, the machine will show one of the following two warnings:

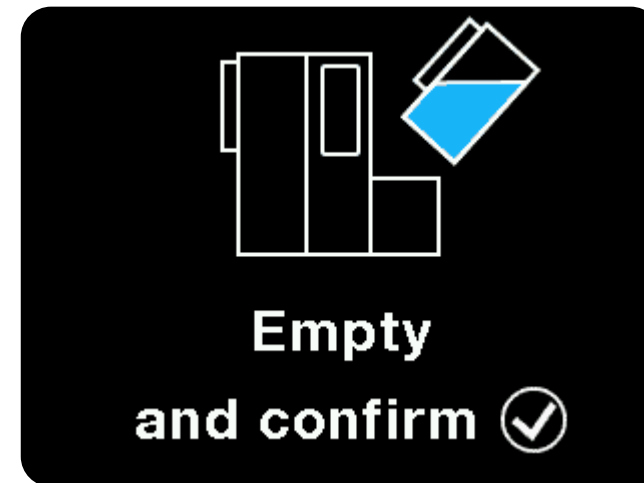
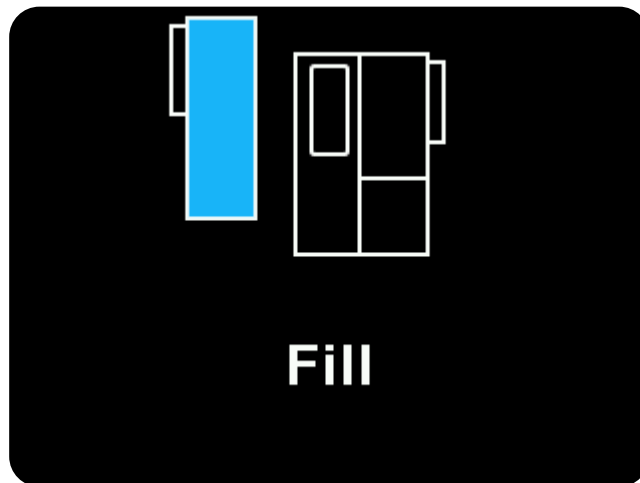

2.8. HOT CLEANING

TheWell has an automated cleaning process; it uses the built-in boiler to create hot water to clean and sanitize the components inside the appliance. The Hot Cleaning Procedure, which takes about 5 minutes, is initiated automatically every two days. The automatic interval can be changed, and hot cleaning can also be started manually from the “Maintenance” menu. This ensures that you always get clean and healthy water, no matter how much time has passed since you last used the machine. The Hot Cleaning Procedure requires the user to do the following:

Remove and completely empty the Tap Water Jar.

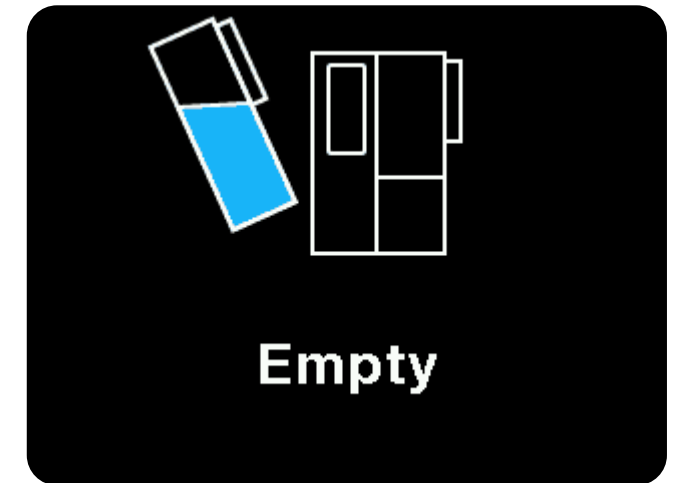

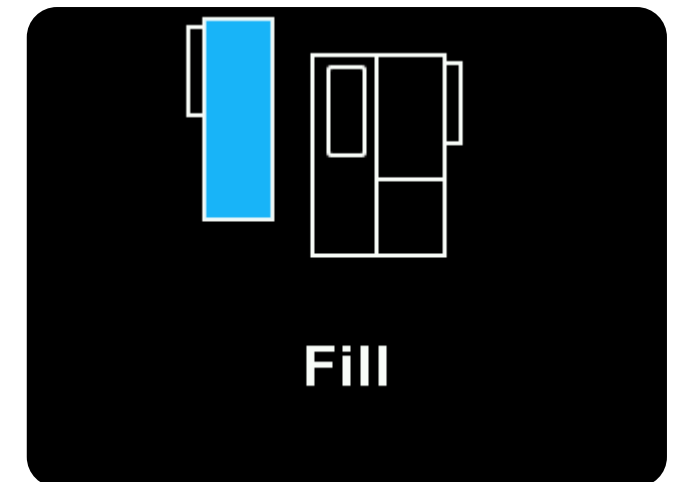

Refill the Tap Water Jar and put it into the left docking station.

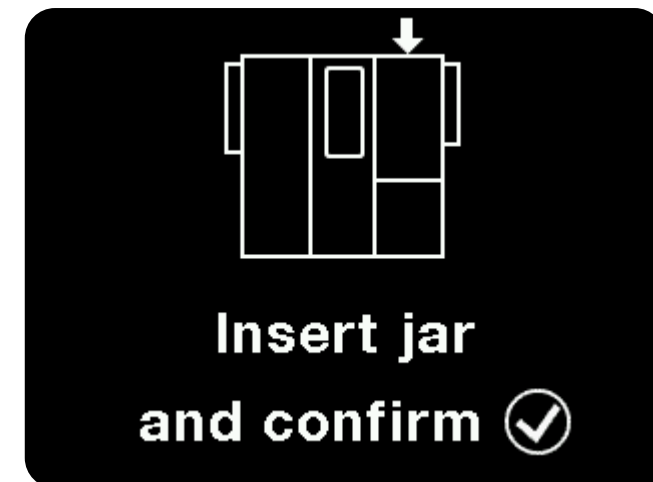

Empty the Clean Water Jar and insert it into the right docking station.

After inserting it press OK  to continue.



The machine will now perform the automated Hot Cleaning Procedure. When finished, empty the Clean Water Jar and confirm by pressing OK  to complete the process.

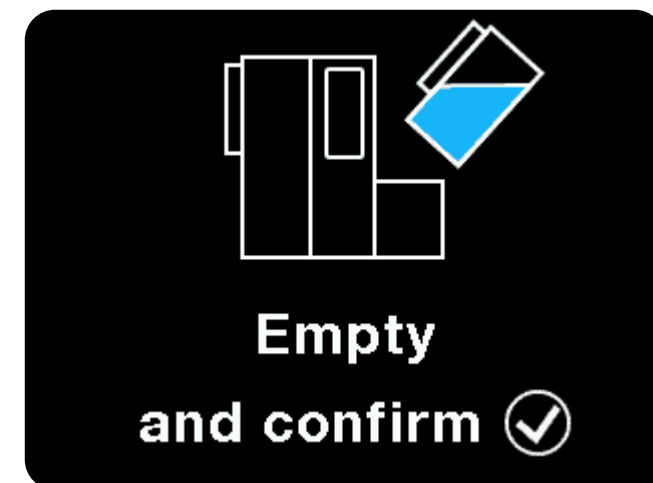

WARNING! DO NOT DRINK THE WATER THAT IS PROCESSED DURING THE HOT CLEANING PROCESS!

Once Hot Cleaning has finished, TheWell is ready for use. Section 3, Normal Operation, explains how to use it.

3. NORMAL OPERATION

3.1 CUP MODE/NORMAL MODE

TheWell has an intelligent feature to automatically detect when the spout is raised or lowered. When the spout is in the raised position, the machine will process a jar or bottle. When the spout is in the lowered position, the machine will process a cup. Fill levels for each mode can be independently configured in the “Configuration” menu.



3.2 COLD, HOT & FLAVORED WATER PROCESSING

1. Turn on the machine .
2. Ensure that the Tap Water Jar is filled and inserted into the left docking station.

IMPORTANT: Always completely empty the Tap Water Jar before refilling it. Never refill the jar while there is still water inside!

3. Place the empty Clean Water Jar, bottle, cup, or glass in the right docking station. If you use a cup or glass, make sure the spout is in the lowered position. This informs the machine to deliver the correct amount and avoids spills.

JAR

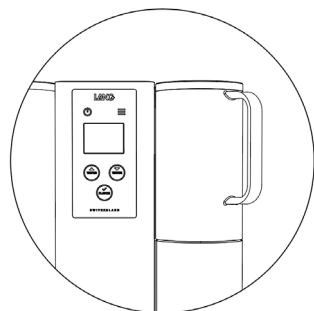

BOTTLE



CUP



GLASS



4. Select COLD WATER , HOT WATER , or FLAVOR  button to start processing. While the machine is processing water, the following information will be displayed:

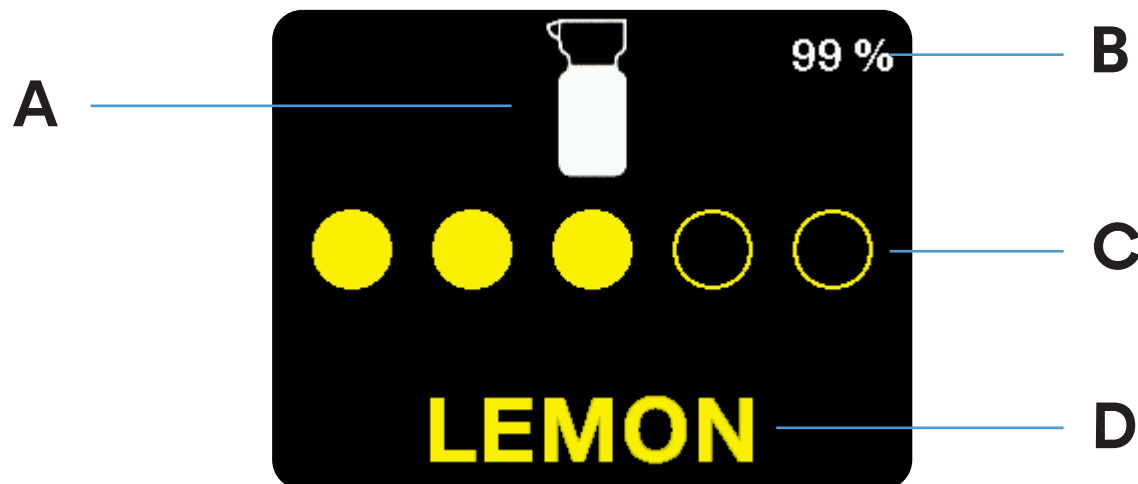

A) The serving size selected (cup  /jar  /bottle  /custom bottle )

B) The percentage of flavor concentrate left in the LANGWATER+ container, when processing FLAVOR.

C) Blue dots for when processing COLD WATER and red dots when processing HOT WATER.

D) The name of the LANGWATER+ flavor, when processing FLAVOR.

IMPORTANT: You can only select FLAVOR  if a LANGPAK+ container is correctly inserted in LANGPAK Slot C. When a LANGPAK+ container is inserted, the logo of the flavor content will be displayed. TheWell will automatically determine if it is a cold (e.g., fruit flavor) or a hot (e.g., tea) beverage and will serve with the correct temperature and amount of flavor. Minerals are also added when a flavor is processed.

After preparing a flavored serving, the machine will display “Finishing” while automatically rinsing the fountain with pure water to make sure that the next serving will not have any residual flavor taste.



Finished

5. The machine will automatically stop processing once the desired fill level is reached (see Section 3.1), or you can manually stop it by pressing

the selected icon again. ((, , ).



WARNING: HOT WATER/HOT SURFACE





3.3 CONSUMING LANGWATER & LANGWATER+

WARNING! LANG purified mineralized water and flavored beverages are completely fresh and do not contain any preservatives. At room temperature, beverages should be consumed the same day, or within three days if refrigerated (less than +8C / 46F).



Always ensure that the Tap Water Jar and Clean Water Jar used when processing fresh LANGWATER and LANGWATER+ beverages do not contain any old water or flavored drinks, and that they are properly washed between use.



3.4 ENERGY SAVING MODE

TheWell has a Stand-by feature that turns the machine off automatically to save energy. If the machine is on Standby, you can turn it on using the

“Power”  button or by pressing any of the HOT WATER, COLD WATER or FLAVOR buttons (, , ).

4. MENU OPTIONS

To enter the configuration menu, press “Menu”  while the machine is in Standby Mode. Use the Up  and Down  buttons to scroll

through the options and press OK  to enter/confirm. While in one of the menus, press “Menu”  to return to the previous menu. To exit the

configuration menu, press “Power”  .

4.1 CUSTOMIZE

TheWell settings can be customized, saving your personal preferences for volume, taste, and temperature of water and beverages. Select Customize in the menu  and choose from the following settings:

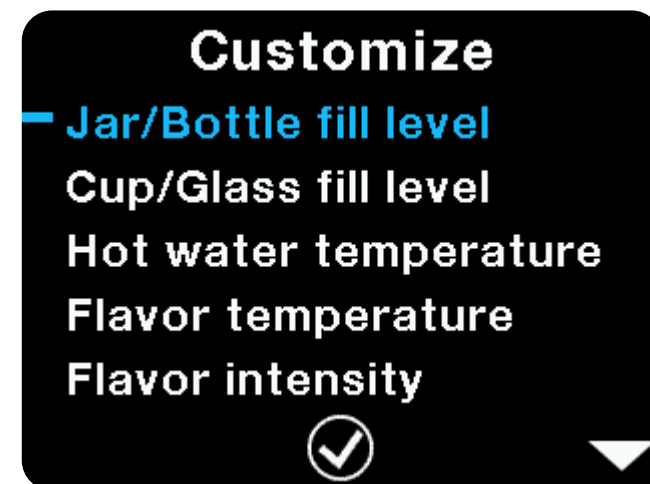

JAR/BOTTLE FILL LEVEL

From this menu item, you can choose whether you want to use the LANG Clean Water Jar, the LANG Bottle, or your own custom bottle or jar. If you choose a custom bottle, you will be prompted to select the desired volume. This setting will affect processing when the spout is in the **raised** position.

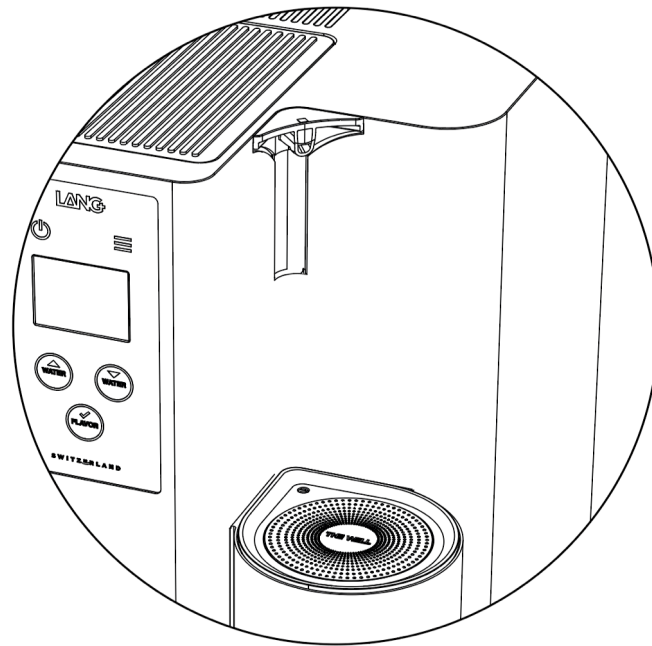

Jar/Bottle fill level

— Jar 1.5L [50 fl oz]

Bottle 1L [34 fl oz]

Custom



Jar/Bottle fill level

1300 ml [44 fl oz]

1400 ml [47 fl oz]

— 1500 ml [51 fl oz] —



CUP/GLASS FILL LEVEL

From this menu item, you can choose how much water you want to process when the spout is in the **lowered** position.

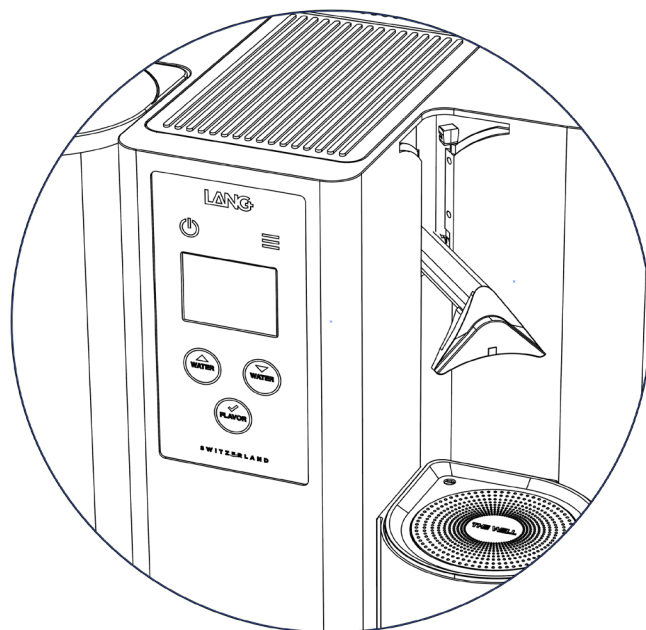

Cup/Glass fill level

150 ml [5 fl oz]

200 ml [7 fl oz]

250 ml [8.5 fl oz]

300 ml [10 fl oz]

350 ml [12 fl oz]



HOT WATER TEMPERATURE

From this menu item, you can select the desired temperature for hot water processing.

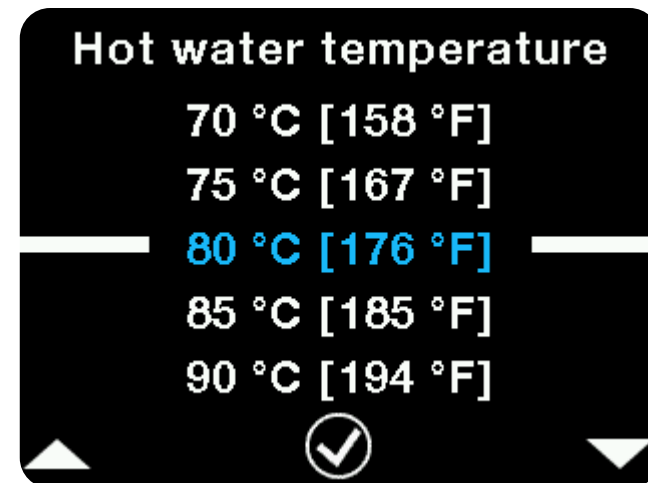

FLAVOR TEMPERATURE

From this menu item, you can customize the temperature of hot flavored drinks. We have already selected the optimal serving temperature for LANGPAK+ flavored drinks, but you can adjust this temperature to your taste.

IMPORTANT: this setting does not affect the temperature of cold flavored drinks.

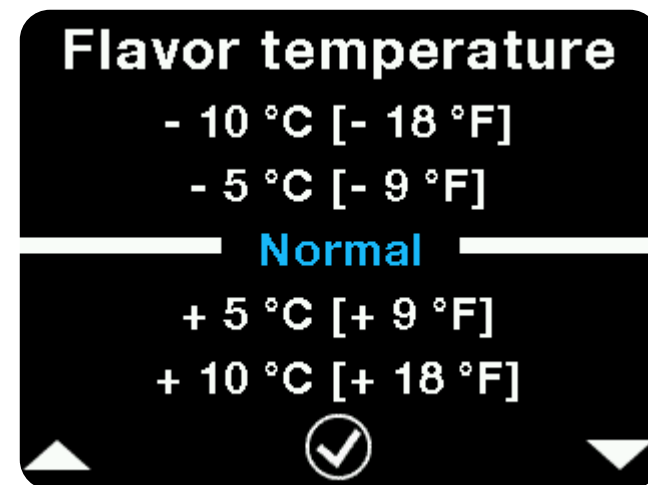

FLAVOR INTENSITY

From this menu item, you can customize the intensity of flavored drinks. We have already selected the optimal concentration for LANGPAK+ flavored drinks, but you can use this menu to make them more or less intense.

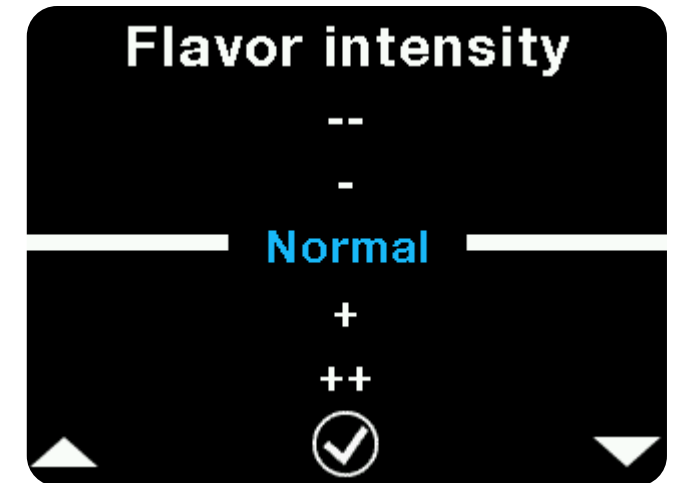

MINERAL INTENSITY

From this menu item, you can customize the mineralization strength of the water. The default setting (Normal) has the optimal intensity for a neutral taste, but you can increase or decrease the amount of minerals added to the purified water.

IMPORTANT: it is not possible for the water to be completely mineral-free. It would be unhealthy and negatively affect the taste.

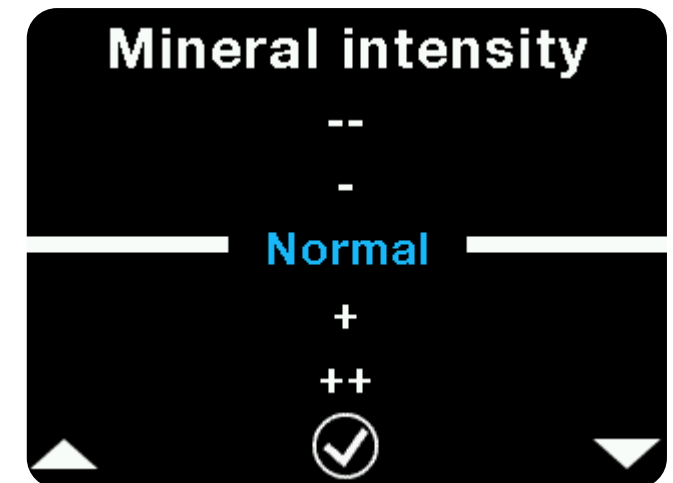

4.2 MAINTENANCE MENU OPTIONS

Most maintenance functions of the TheWell are automated, but they can also be started manually. The Maintenance menu allows you to begin processes that include hot cleaning, descaling, and changing the filters. You can also customize the schedules for some of the automated maintenance processes.

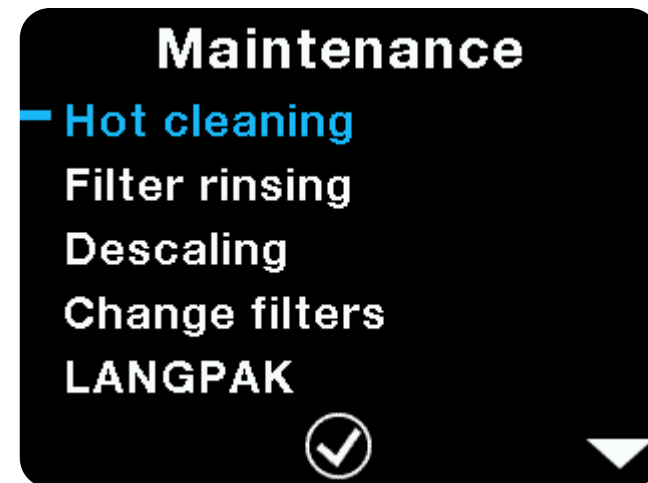

HOT CLEANING

Choose "Hot cleaning" and then press Yes to start the Hot Cleaning Procedure, described in Section 2.9.

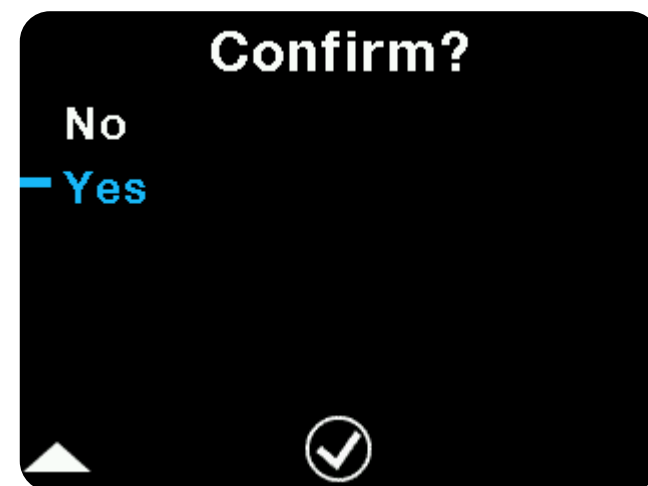

FILTER RINSING

Choose “Filter rinsing” and then press Yes to start the Filter Rinsing Procedure, described in section 5.7.

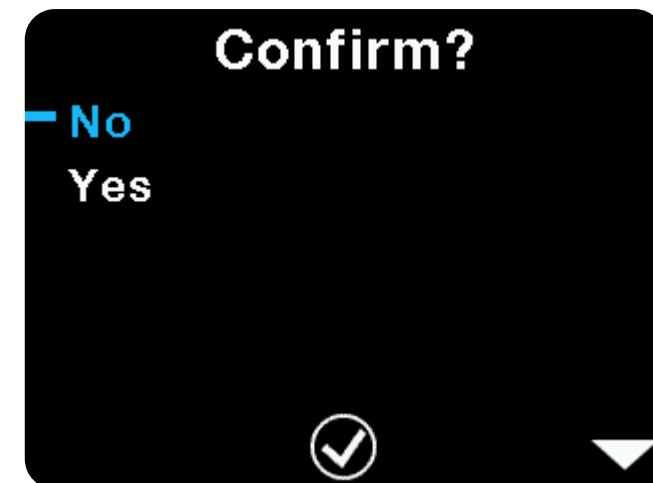

DESCALING

Choose Descaling and then press Yes to start the Descaling Procedure, described in Section 5.5.

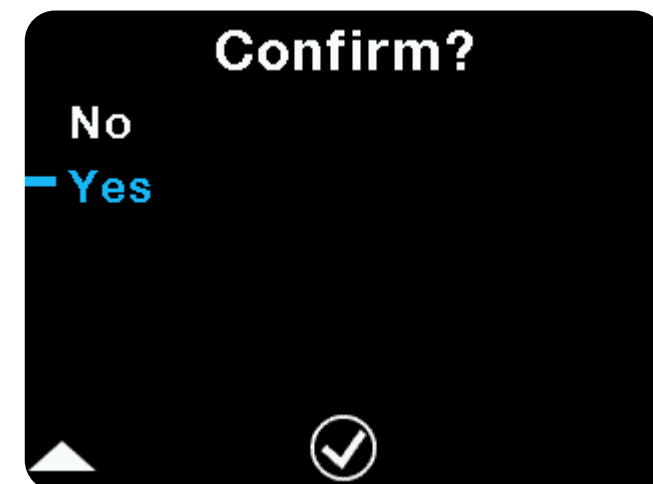

CHANGE FILTERS

Choose Change filters and then press Yes to begin the process of changing the filters, described in Section 2.8.

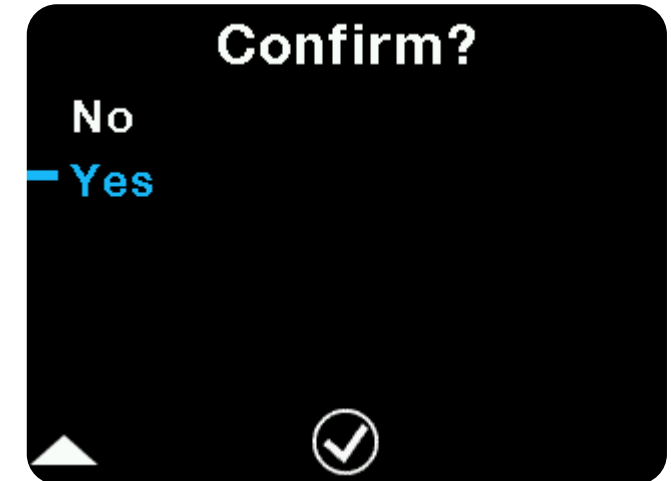

LANGPAK

Choose "LANGPAK" to check the status of your LANGPAKs.



MAINTENANCE SCHEDULE

From this menu item, you can check to see when the filters need to be replaced. This allows you to order them in advance. It also displays the next scheduled hot cleaning cycle.



Maintenance schedule

Current date
27 Oct 2020

Hot cleaning
29 Oct 2020

Change filters
27 Oct 2022

The screenshot shows a black rounded rectangle with white text. The title 'Maintenance schedule' is at the top. Below it, 'Current date' is followed by '27 Oct 2020' in blue. Then 'Hot cleaning' is followed by '29 Oct 2020' in blue. Finally, 'Change filters' is followed by '27 Oct 2022' in blue.

HOT CLEANING INTERVAL

From this menu item, you can customize the interval between hot cleaning cycles. We recommend hot cleaning every two days.

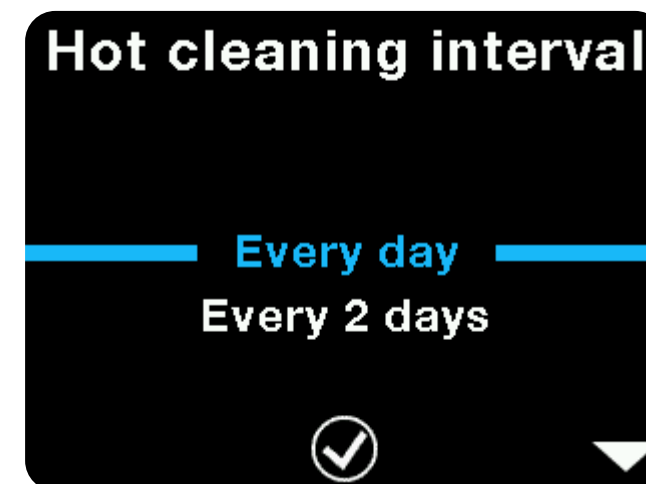

Hot cleaning interval

Every day

Every 2 days

✓

▼

The screenshot shows a black rounded rectangle with white text. The title 'Hot cleaning interval' is at the top. Below it, 'Every day' is highlighted with blue horizontal bars on either side. Below that, 'Every 2 days' is shown. At the bottom, there is a white checkmark icon in a circle on the left and a white downward-pointing triangle icon on the right.

4.3 SETUP MENU

Select Setup in the menu  to access the following settings:

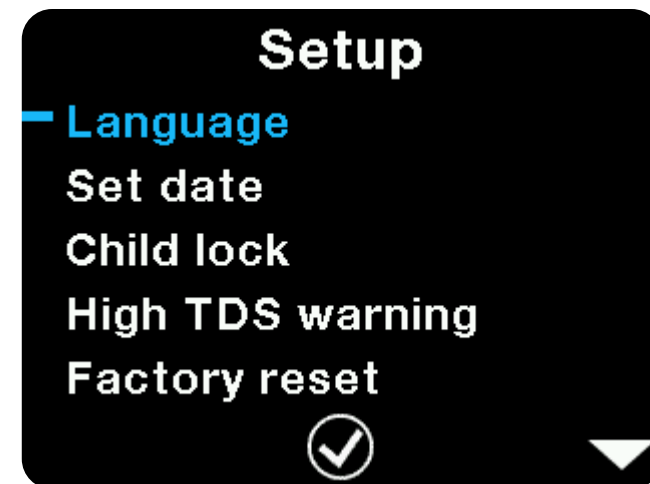

LANGUAGE

From this menu item, you can change the user interface language, as described in Section 2.4.

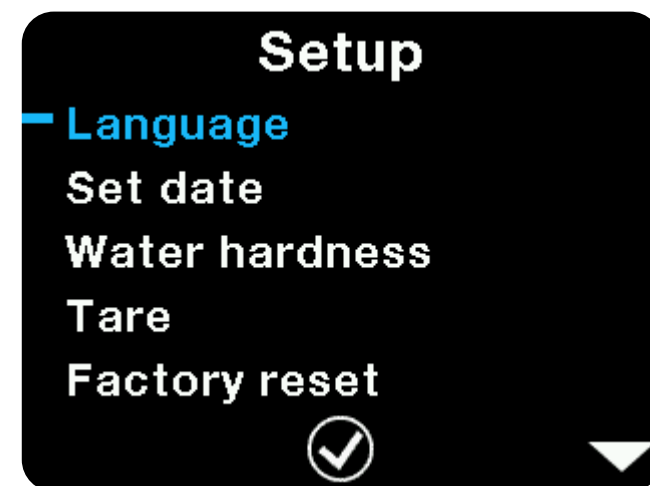

SET DATE

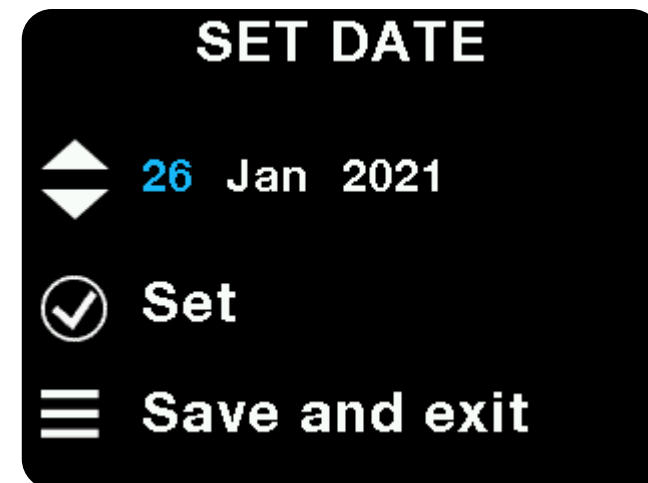

From this menu item, you can change the current date of the machine, as described in Section 2.7. If the machine has not been connected to power for a long time, it will prompt you to update the date.



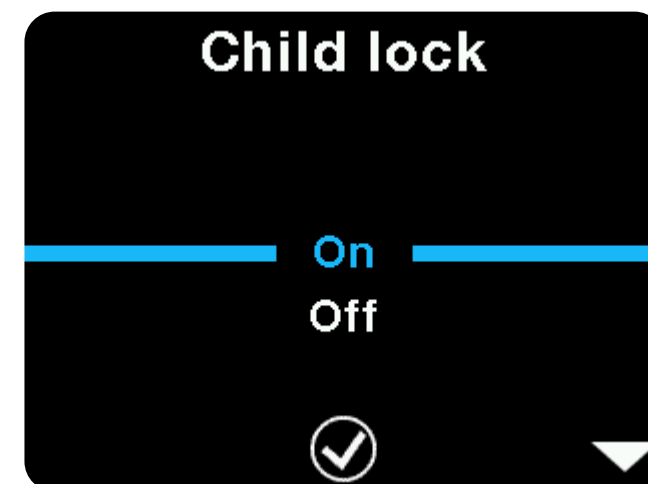

CHILD LOCK

The LANG machine has an optional safety feature that prevents children from processing hot water without the help of an adult.



If Child Lock is enabled, when Hot Water  or hot Flavors  are selected the machine will display



To temporarily disable the child lock and process Hot Water  or hot Flavors  press Menu  for 3 seconds until the machine shows



The Child Lock feature will remain disabled until the LANG machine goes into standby.

HIGH TDS WARNING

The LANG machine has a sensor to detect the quality of the tap water. As the water gets purified during the processing, the water in the tap water jar will start accumulating the particles and ions that are filtered out of the clean water. At high TDS levels the lifetime of the filter starts decreasing. To avoid this, the LANG machine will prompt the user to empty and refill the tap water jar once the water reaches a critical level. To disable the warning, select “Off” and Confirm.

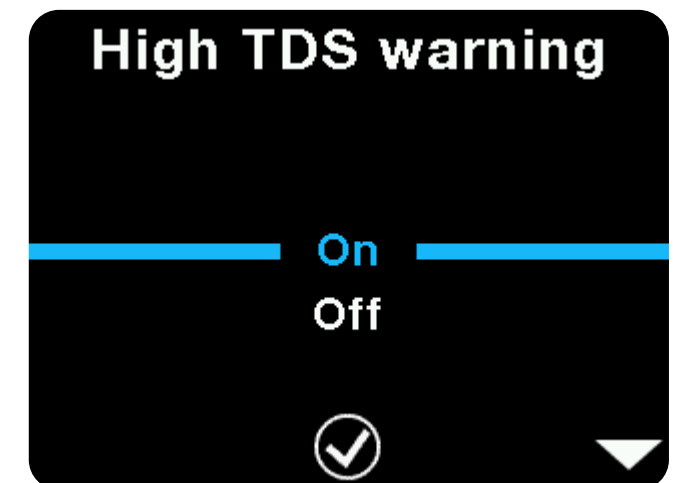

FACTORY RESET

This function can be used to restore the appliance to the factory state.

IMPORTANT: You will lose all your customizations if you perform this procedure.

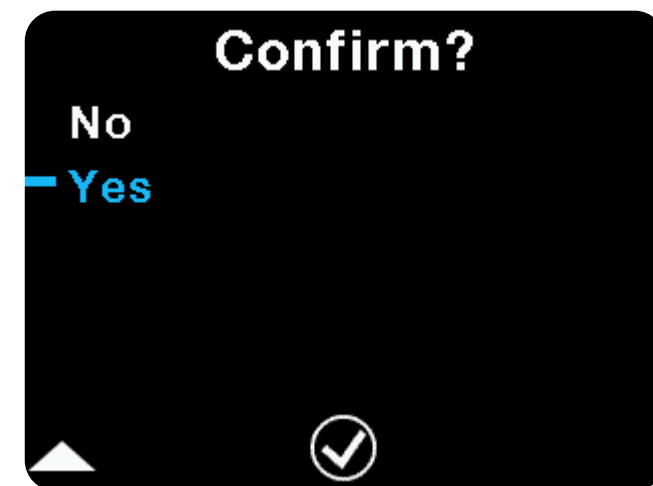

FIRMWARE VERSION

This menu item is used to check the version of firmware installed in TheWell appliance.

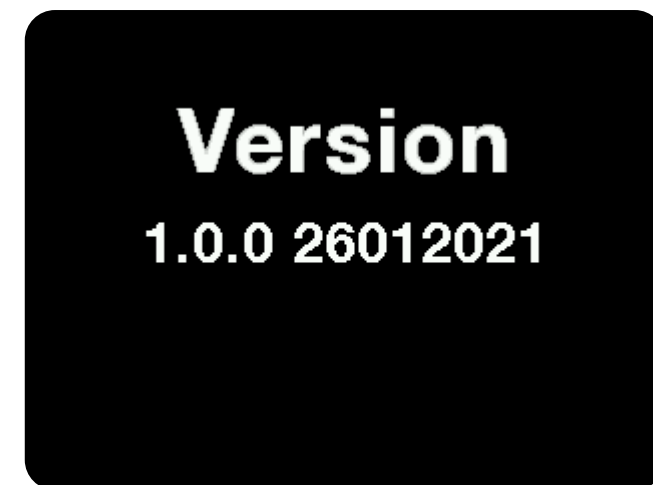

5. MAINTENANCE

5.1 CLEANING

Always wash the jars thoroughly before using them. The jars are dishwasher-safe, so you can wash them together with other dishes. You can also wash them with warm water and soap.

All the plastic parts on the machine's exterior can be cleaned with warm water and soap. Avoid pouring water into the LANGPAK compartment. Use a damp cloth to clean it.

5.2 DRIP TRAY

TheWell comes with a tray in the center to collect the evaporation that forms while processing hot water. Empty and clean the tray regularly.

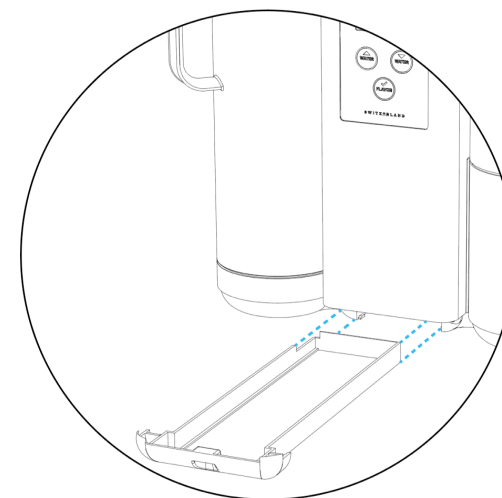

5.3 AUTOMATED MAINTENANCE CYCLES

TheWell features automated maintenance procedures that ensure hassle-free optimal performance.

5.4 HOT CLEANING

Hot Cleaning is an automated process that uses the built-in boiler to create hot water to clean and sanitize the components inside the appliance. The Hot Cleaning Procedure, which takes about 5 minutes, is initiated automatically every two days. The automatic interval can be changed, and hot cleaning can also be started manually from the “Maintenance” menu. This ensures that you always get clean and healthy water, no matter how much time has passed since you last used the machine.

The Hot Cleaning Procedure is described in detail in Section 2.9 of Setup.

5.5 CHANGING THE FILTERS

The filters must be replaced every two years. The machine will display a warning message when they are due for replacement, so you can order and insert new ones.

When new filters are inserted in the appliance, they need to be filled and rinsed before they can be used to process water. The procedure is automated, but it takes about 25 minutes, and it requires that the user be available to fill the Tap Water Jar with clean water and empty the Clean Water Jar when it is full.

The Setting Up Filters Procedure is described in detail in Section 2.8 of Setup.

5.6 DESCALING

Depending on the hardness of your tap water, calcium deposits may form inside the appliance. Over time, these calcium deposits may reduce the performance of the machine and the filters and potentially reduce their lifespan. If you notice that the machine is operating more slowly, calcium deposits may already have formed inside. To remove the calcium deposits, the machine has an automated Descaling Procedure, which requires the two Special Descaling Cartridges (SDC) included with TheWell, as well as 50 grams of citric acid.

IMPORTANT: To ensure the best life of your filters, we recommend you execute this procedure every 6 months, even if you are not sure about the hardness of your tap water or you know it is not hard.

Begin the Descaling Procedure by going into the “Maintenance menu” and selecting “Descaling.”



Replace Filter Cartridges 1 and 2 with the Special Descaling Cartridges (SDC) that came with TheWell appliance.

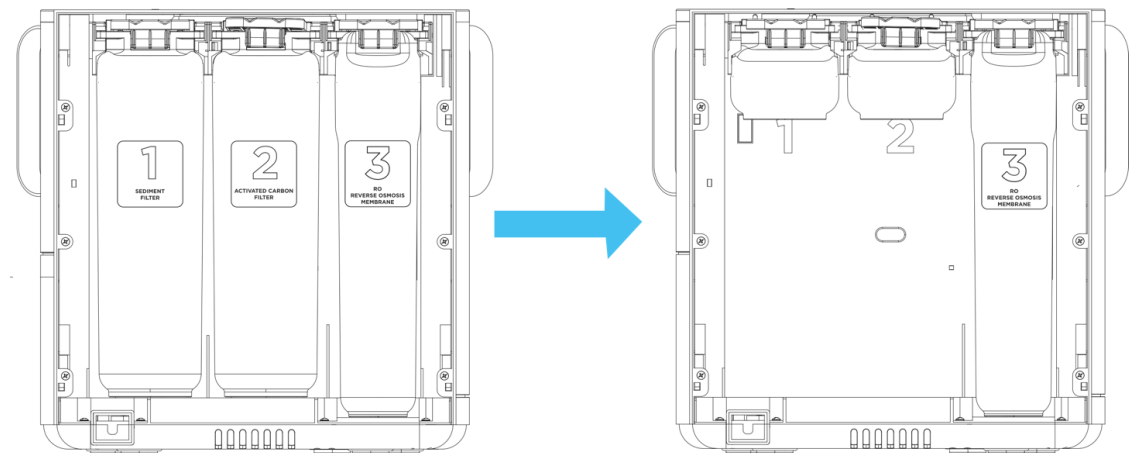

Make sure to lock the latches in place. Press OK  to continue.



The machine will prompt you to empty and refill the Tap Water Jar. Ensure the jar is completely filled and correctly inserted in the left docking station.

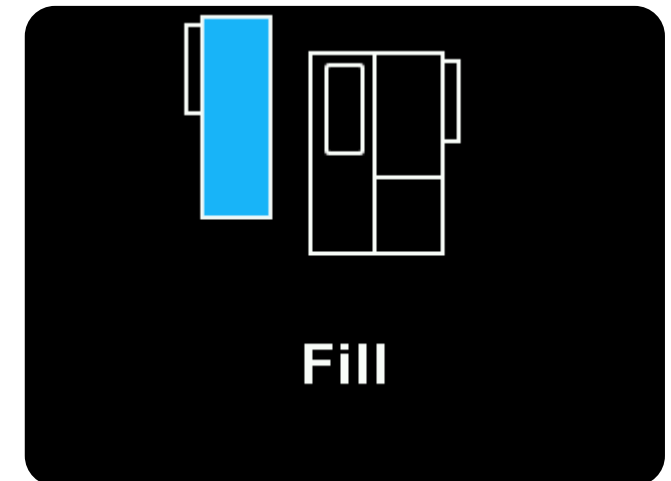

After the Tap Water Jar is properly inserted, the machine will prompt you to empty and place the Clean Water Jar into the right docking station.

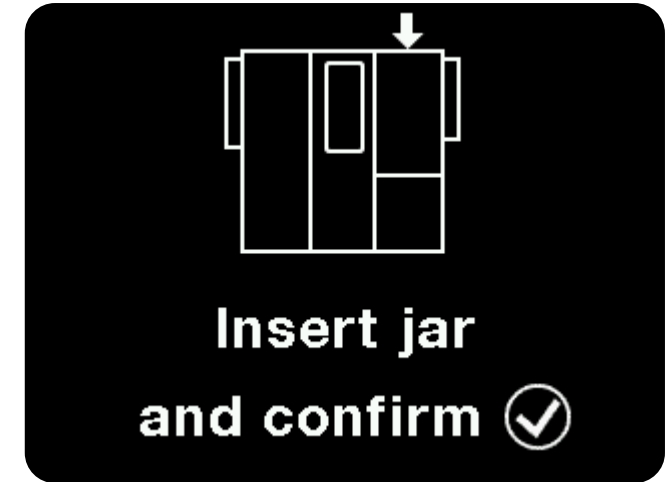

Add the LANG descaling additive (available for purchase from the LANG website, www.drinklang.com) to the Tap Water Jar. You can also use 50 grams (10 tsps.) of citric acid, which can be found in many local grocery stores or supermarkets. There is no need to stir after you have added the additive to the Tap Water Jar. Once you have measured and added it, press

OK  to continue.

The text 'OK' is followed by a white checkmark icon inside a circle, and then the text 'to continue.'

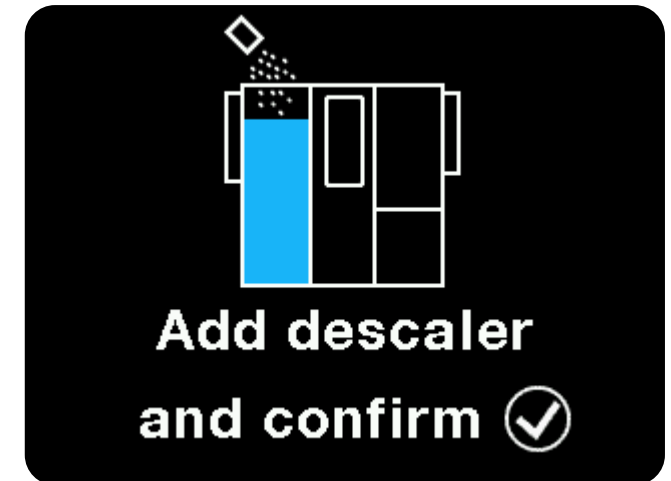

The machine will now start the automated Descaling Procedure, which takes about 25 minutes. The time remaining until completion will be displayed on the screen.

WARNING! DO NOT TURN OFF THE POWER DURING THIS PROCEDURE.

Once the automated procedure is finished, replace the Special Descaling Cartridges (SDC) with the original filter cartridges.



The machine will now flush the internal pipes with two jars of water to remove all the descaling agent. Empty and refill the Tap Water Jar and place it in the left docking station.

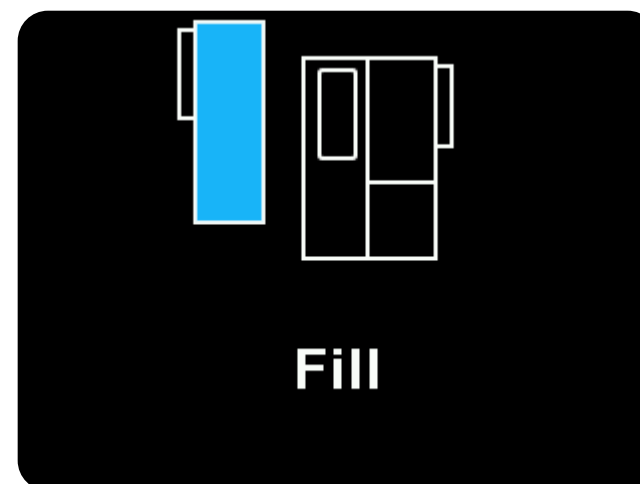
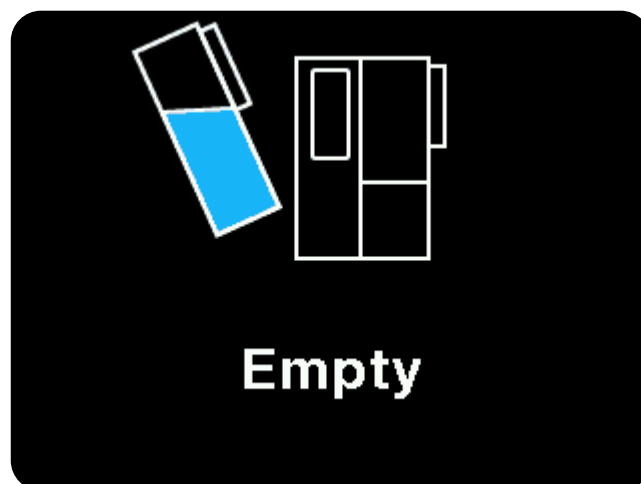

IMPORTANT: Be sure to empty the Tap Water Jar completely before refilling.

The machine will now ask you to place an empty Clean Water Jar in the right docking station.

Insert the jar and press OK  to continue.

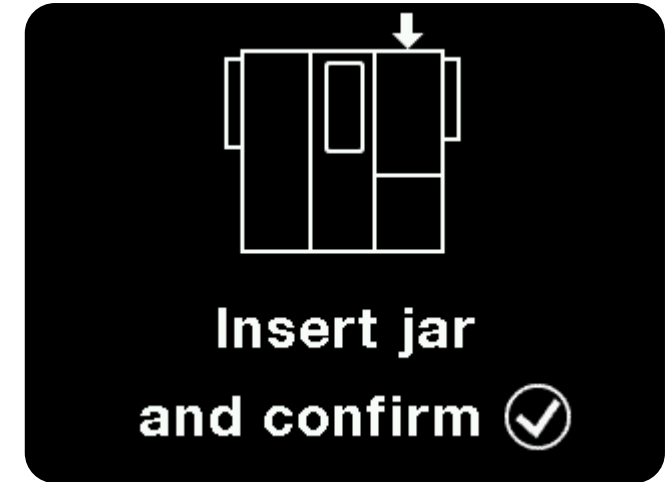

The machine will now process one full jar.

Once it has finished one jar, it will ask you to empty and refill the Tap Water Jar and place it in the left docking station.

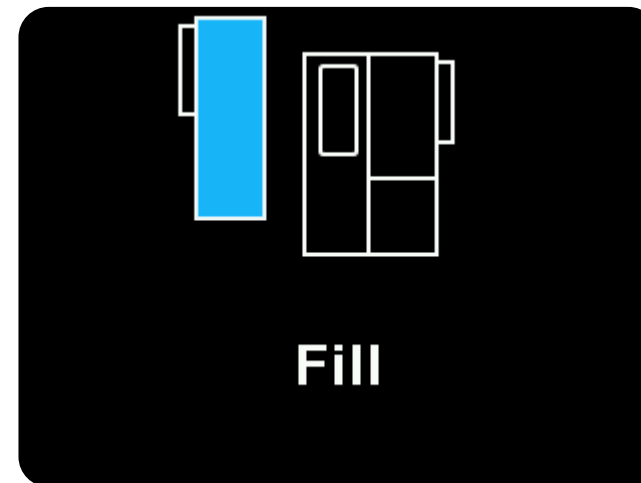
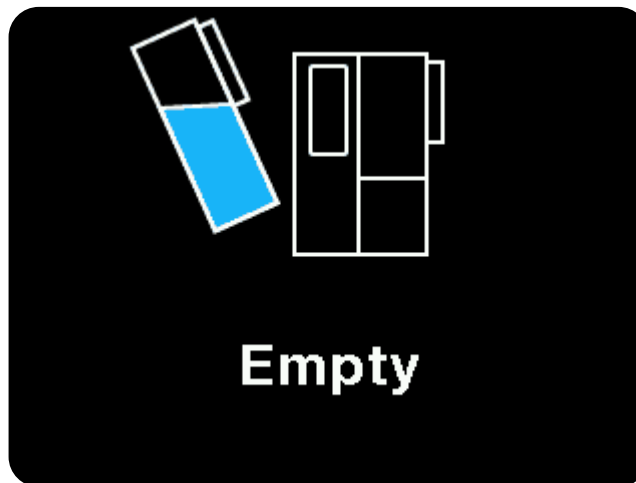

IMPORTANT: Be sure to empty the Tap Water Jar completely before refilling.

The machine will now ask you to place an empty Clean Water Jar in the right docking station. Insert the jar and press OK  to continue.

The machine will now process the second full jar.

The machine has now been cleaned and the Descaling Procedure finished.

Descaling

finished

IMPORTANT: After the Descaling Procedure, the clean water may have a hint of lemon flavor. This is perfectly fine and comes from the natural descaling additive, which is not harmful for your health. If you want to remove any residual lemon flavor, process another full Clean Water Jar.

5.7 FILTER RINSING

The Filter Rinsing procedure can be used to do a deep cleaning and/or a disinfection of the filters. The LANG machine will ask the user to empty and refill the tap water jar with clean water and let water run at high speed through the filters to remove all sediments that may have formed over time. Optionally, Hydrogen Peroxide (a common disinfectant) can be added to the water to disinfect the filters.

As a first step, the machine will ask to empty the tap water jar.

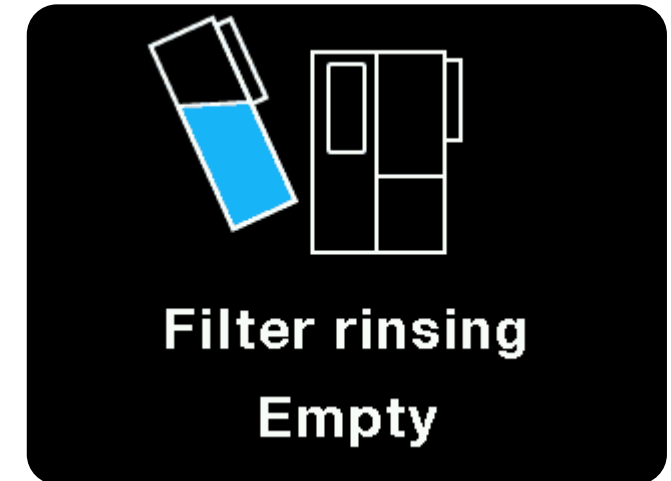

The machine will then ask the user to refill the tap water jar. If a disinfection of the filters must be performed, 125 ml of 3% hydrogen peroxide can be added inside the tap water. Stirring is not needed.

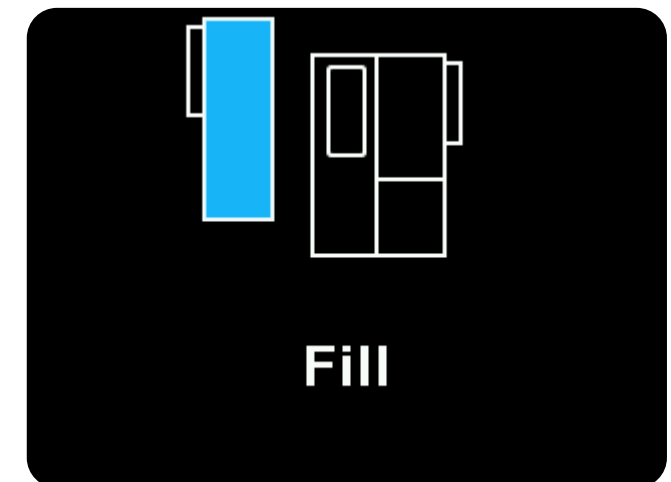

The machine will then ask to insert the clean water jar and press “OK”  to confirm.

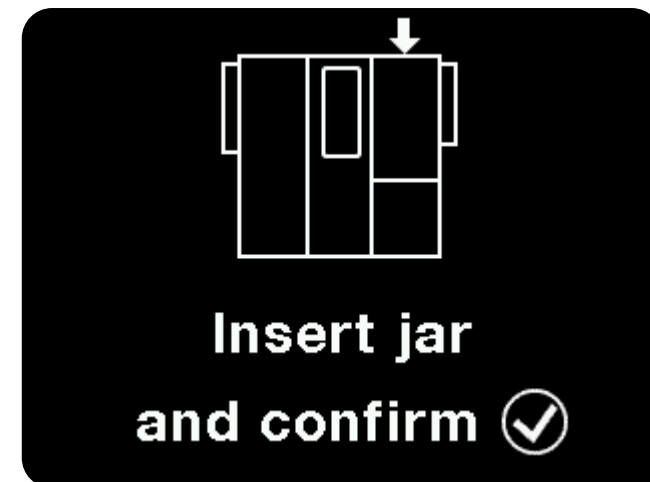

The machine will then start rinsing the filters for 15 minutes.

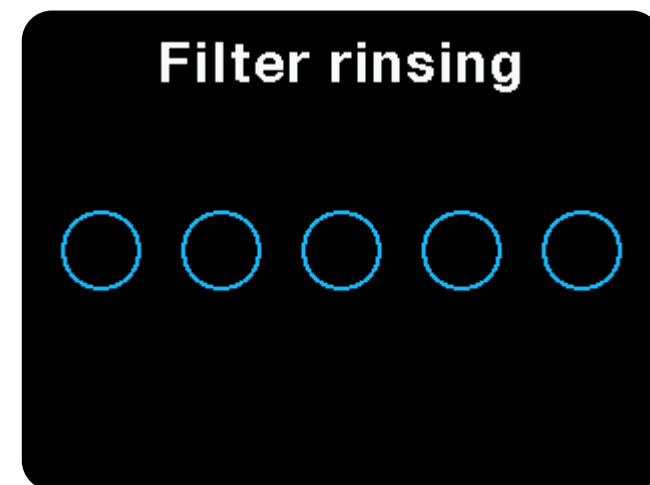

After the rinsing procedure has finished, the machine will ask to empty the clean water jar and

press “OK”  to confirm

The tap water jar must then be emptied and refilled with clean water.

WARNING: Do not drink the water from the Filter Rinsing procedure.

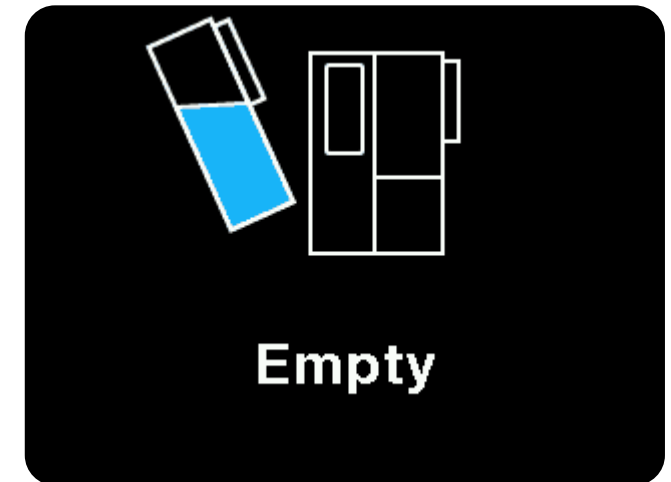
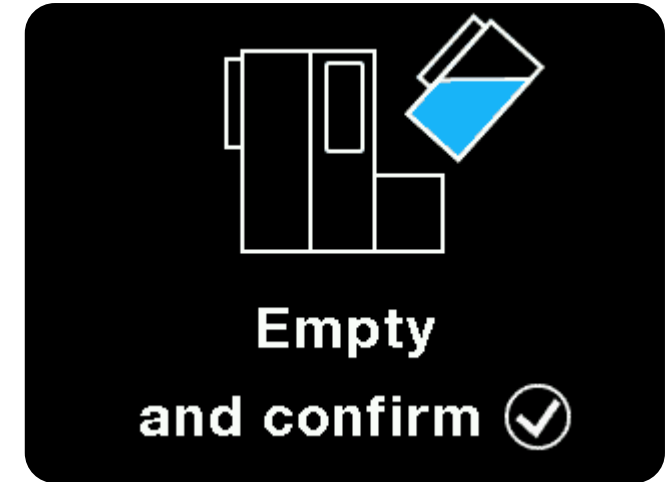

6. TROUBLESHOOTING

Refer to this section if you experience problems during processing or use.

IF THE MACHINE DOES NOT TURN ON

Make sure the power cable is correctly attached and there is power at the outlet. Press “Power” (add power icon) to turn on the machine. If it fails to turn on, contact LANG Technical Support.

WATER LEAKAGE

Make sure the Tap Water Jar is correctly positioned (see Section 2.5). If the leakage persists, contact Lang Technical Support.

MACHINE OPERATES SLOWLY

There may be calcium deposits inside the appliance. Perform a Descaling Procedure (see Section 5.5 under Maintenance).

Following are messages you may encounter and what they indicate.

MISSING CLEAN WATER JAR/BOTTLE/CUP

Place the jar or cup in the right docking station and wait for the error to disappear. There is a weight sensor, so do not leave your hand on the jar or cup after setting it in the docking station.

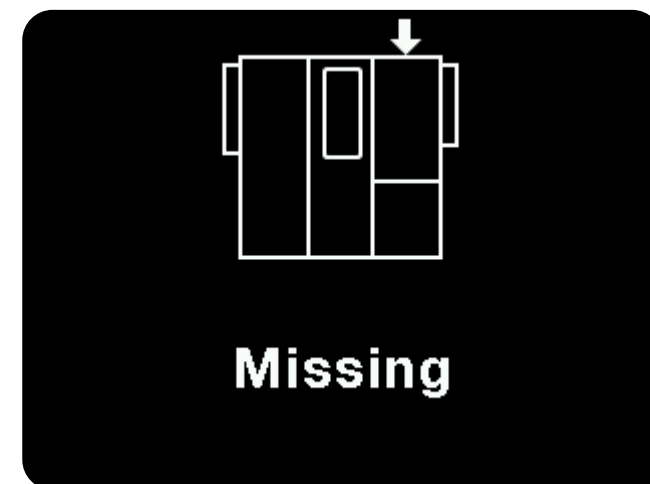

MISSING TAP WATER JAR

Insert the Tap Water Jar into the left docking station and wait for the error to disappear.

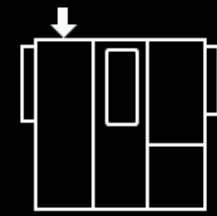

Missing

CLEAN WATER JAR/CUP/BOTTLE FULL

The machine has finished processing water and the drink is ready.



Full

FLAVOR EMPTY

The LANGPAK+ flavor container is empty and needs to be replaced.

LEMON

empty

MINERAL MISSING

The LANGPAK mineral containers are missing or not inserted correctly. Remove and re-insert. Make sure the lid closes completely.

IMPORTANT: The machine will only operate when both Mineral A and Mineral B containers are inserted. The machine will also detect when the containers are empty and will stop operating until replaced. LANGPAK Mineral A and Mineral B containers are always changed together.

Minerals

missing

LOW MINERALS

The LANGPAK mineral containers are almost empty. Order new ones from www.drinklang.com before you run out.

Low

minerals

MINERALS EMPTY

The LANGPAK mineral containers are empty and need to be replaced. The machine will only operate when both Mineral A and Mineral B containers are inserted. The machine will also detect when the containers are empty and will stop operating until replaced.

IMPORTANT: LANGPAK Mineral A and Mineral B containers are always changed together.

Minerals

empty

LANGPAK ERROR

You have inserted the wrong type of LANGPAK container (e.g., two flavor containers or two Mineral A containers). The three slots must have one Mineral A, one Mineral B, and one optional flavor. You can only insert one flavor at a time.

CHANGE FILTERS

Every two years, you must replace the filter cartridges. When you see this warning, order new filters from www.drinklang.com and replace them as soon as possible.

ERROR 1 FLOW METER

Contact LANG Technical Support.

Minerals

missing

Change

filters

Error

1

Flow meter

ERROR 2 TOUCH

Remove the power cable, wait one minute, then plug it in again. If the problem persists, contact LANG Technical Support.

Error

2

Touch

ERROR 3 FLASH

Contact LANG Technical Support.

Error

3

Flash

ERROR 4 FLOW RATE

This may happen if there are calcium deposits inside the appliance. Perform a descaling procedure (see Section 5.5). If the calcium deposits were particularly strong, you may also have to replace the filters. If the problem persists, contact LANG Technical Support.

Error

4

Low flow rate

ERROR 5 MICROPUMPS

This may occur if the LANGPAK containers have not been used for a long time. Remove the power cable and clean the LANGPAK compartment inside the machine with a damp, soapy cloth. Wipe off any soap residue with a damp cloth. Then remove the LANGPAK containers, shake them vigorously, and reinsert them into the machine. If the problem persists, contact LANG Technical Support.

ERROR 6 LOW TEMPERATURE

The machine cannot reach the desired hot water temperature. Remove the power cable, wait one minute, then plug it in again. If the problem persists, contact LANG Technical Support.

ERROR 7 HIGH TEMPERATURE

Remove the power cable, wait one minute, then plug it in again. If the problem persists, contact LANG Technical Support.

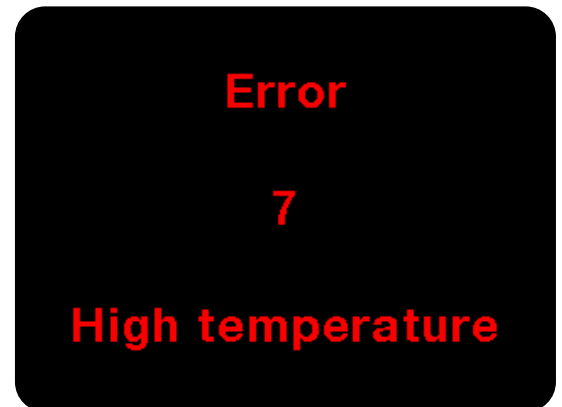
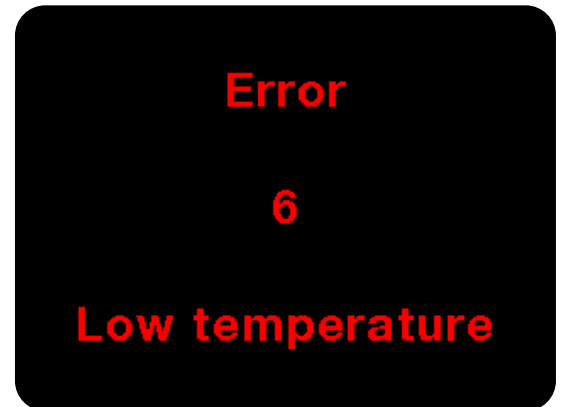

ERROR 8 LANG NFC

Remove the power cable, wait one minute, then plug it in again. If the problem persists, contact LANG Technical Support.

Error
8
Langpak NFC

ERROR 9 BOILER

Remove the power cable, wait one minute, then plug it in again. If the problem persists, contact LANG Technical Support.

Error
9
Boiler

ERROR 10 MICROPUMPS

Remove the power cable, wait one minute, then plug it in again. If the problem persists, contact LANG Technical Support.

Error
10
Micropump

7. PRODUCT INFORMATION

Model: C010-rev.05

Temperature operating range: 10 - 35 °C

Tap water temperature range: 5 - 35 °C

US Ratings:

RATINGS
120 Vac/60Hz
1500W/Class I

EU Ratings:

RATINGS: 230 Vac
50-60Hz, 800W, Class I
Max. Input: 1500W

Manufacturer: LANG Beverages SA

Address: Baarerstrasse 125, 6300 Zug, Switzerland

ENVIRONMENT-FRIENDLY DISPOSAL



You can help protect the environment!

Please respect local regulations: dispose of any non-functional electrical equipment at an appropriate waste disposal center.

TheWell

WWW.DRINKLANG.COM