

**LANG**  
SWITZERLAND



**TheWell 2**

TheWell 2 - User Manual 1.0

# Operations Guide **Safety Precautions**



**CAUTION: WHEN YOU SEE THIS SIGN, PLEASE REFER**

**TO THE SAFETY PRECAUTIONS TO AVOID HARM AND DAMAGE.**

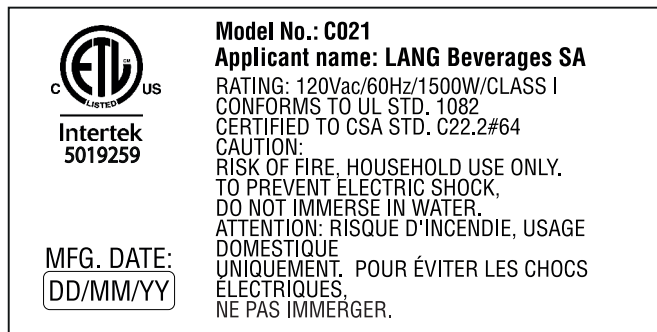
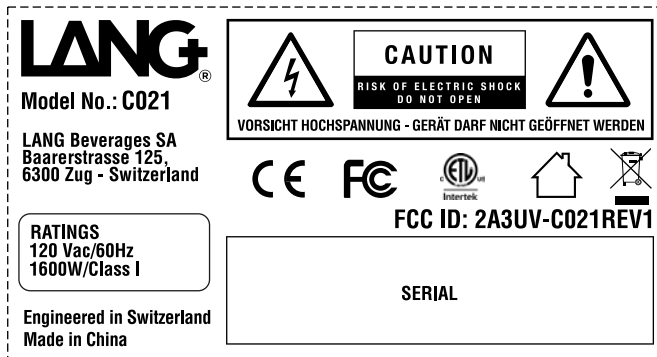

**ASSISTANCE VIDEOS AN FAQ SECTION ARE AVAILABLE AT [WWW.DRINKLANG.COM](http://WWW.DRINKLANG.COM) VISIT “SUPPORT” SECTION**

This device complies with Part 15 of the FCC Rules. Operation is subject to the following two conditions: (1) this device may not cause harmful interference, and (2) this device must accept any interference received, including interference that may cause undesired operation.

Changes or modifications to this unit not expressly approved by Lang Beverages sa could void the user's authority to operate the equipment.

**NOTE:** This equipment has been tested and found to comply with the limits for a Class B digital device, pursuant to Part 15 of the FCC Rules.

These limits are designed to provide reasonable protection against harmful interference in a residential installation.

This equipment generates uses and can radiate radio frequency energy and, if not installed and used in accordance with the instructions, may cause harmful interference to radio communications.

However, there is no guarantee that interference will not occur in a particular installation. If this equipment does cause harmful interference to radio or television reception, which can be determined by turning the equipment off and on, the user is encouraged to try to correct the interference by one or more of the following measures:

- Reorient or relocate the receiving antenna.
- Increase the separation between the equipment and receiver.
- Connect the equipment into an outlet on a circuit different from that to which the receiver is connected.
- Consult the dealer or an experienced radio/TV technician for help.

Changes or modifications to this product not authorized by Lang Beverages sa may void compliance with electromagnetic compatibility (EMC) and wireless standards, as well as the authorization to use the product.

## FCC Radiation Exposure Statement

The equipment complies with FCC radiation exposure limits set forth for an uncontrolled environment. The equipment should be installed and operated with minimum distance 20cm between the radiator & your body.

These instructions are part of the appliance. Read all instructions and safety instructions before operating the appliance.

When using electrical appliances, basic important safeguards should always be followed, including the following:

- Read all instructions.
- Do not touch hot surfaces. Use handles or knobs.
- Do not use outdoors.
- Always attach plug to appliance first, then plug cord into the wall outlet. To disconnect, turn any control to “off,” then remove plug from wall outlet.
- Do not let cord hang over edge of table or counter, or touch hot surfaces.
- The appliance is intended to prepare beverages according to these instructions.
- This appliance should only be used for intended purpose.
- This appliance is only meant for indoor use, under non-extreme temperature conditions.
- The appliance must not be used, cleaned, or maintained by children under 8 years of age unless supervised, instructed by an adult on how to use the appliance safely, and fully

informed regarding the dangers involved.

- Close supervision is necessary when any appliance is used by or near children.
- Keep appliance / power cord / LANGPAK out of reach of children.
- Children should not use the appliance.
- This appliance may be used by persons with reduced physical, sensory or mental capabilities, or whose experience or knowledge is not sufficient, provided they are supervised, or has received instruction to use the device safely and understand the dangers.
- Any servicing other than cleaning and user maintenance should be performed by an authorized service representative.

Avoid risk of fatal electrical shock and fire to protect against fire, electric shock and injury to persons

- Do not operate any appliance with a damaged cord or plug or after the appliance malfunctions, or has been damaged in any manner. Return appliance to the nearest authorized service facility for examination, repair or adjustment.
- If the cord or the plug are damaged, do not operate the appliance.
- To disconnect, turn the appliance "OFF", then remove the plug from the outlet.
- To avoid hazardous damage, never place the appliance on or beside hot surfaces such as radiators, stoves, ovens, gas burners, electric burner, open flames, or similar.
- Unplug from outlet when not in use and before cleaning. Allow to cool before putting on or taking off parts, and before cleaning the appliance.
- To protect against fire, electric shock and injury to persons do not immerse cord, plugs, or (state specific part or parts in question) in water or other liquid.
- Electricity and water together are dangerous and can lead to fatal electric shocks.
- Do not put anything else than specified LANGPAK containers and filter cartridges into the appliance. Doing so may cause fire or electric shock!
- The use of accessory attachments not recommended by the appliance manufacturer may result in fire, electric shock, or injury to persons.

Avoid possible harm when operating the appliance.

- Risk of scalding by hot liquids. If the system is forced open hot liquids may splash. Never open it during operation.

## SAVE THESE INSTRUCTIONS

This Instruction Manual is also available as a PDF file at [www.drinklang.com](http://www.drinklang.com)

## OTHER SAFEGUARDS

When using electrical appliances, important safeguards should always be followed, including the following:

- The important safeguards are part of the appliance. Read the important safeguards provided with the appliance carefully prior to first use. Keep them in a place where you can find and refer to them in the future.
- Protect the appliance from direct sunlight, water splash and humidity.
- This appliance is designed for domestic use only.
- Close supervision is necessary when the appliance is used by or near children.

- Children shall not play with the appliance.
- The manufacturer accepts no responsibility for and the warranty will not apply to any commercial use, inappropriate handling or use of the appliance, damage resulting from use for other purposes, faulty operation, non-professional repairs or failure to comply with the instructions.

Avoid risk of fatal electrical shock and fire to protect against fire, electric shock and injury to persons.

- In case of emergency: immediately remove the plug from the power outlet.
- Only plug the appliance into suitable, easily accessible, grounded outlets. Make sure that the voltage of the power source is the same as that specified on the rating plate. The use of an incorrect voltage or frequency of electricity voids the warranty.
- Do not pull the cord over sharp edges, clamp it or allow it to hang down.
- Keep the cord away from heat and moisture.

Always place the appliance on a horizontal, stable, hard, even surface that does not allow for water accumulation under the appliance.

- The surface must be resistant to heat and fluids, like water, tea, descaler or similar.
- Disconnect the appliance from the power outlet when not in use for a long period of time.
- Disconnect by pulling out the plug; do not pull on the cord itself to avoid damage.
- Never touch the cord with wet hands.
- Never put the appliance in a dishwasher.
- Do not open the appliance. Hazardous voltage inside!
- Do not dismantle the appliance.

Avoid possible harm when operating the appliance

- Never leave the appliance unattended during operation.
- Do not use the appliance if it is damaged or not operating perfectly. Immediately remove the plug from the power outlet. Contact the Lang Beverages authorized representative for examination, repair or adjustment. A damaged appliance can cause electric shocks, burns and fire.
- Do not put fingers under water outlet; risk of scalding.
- Beware of hot liquids.
- Never use a damaged or deformed LANGPAK.
- Always completely empty the tap water jar before refilling with fresh tap water.
- Do not use any other liquids than water (such as cow's milk, soya milk, enriched milks, flavored liquids, etc.).
- Do not overfill tap water jar.
- Empty the jar if the appliance will not be used for an extended time (holidays, etc.).
- Do not use the appliance without a bottle, jar, glass or cup placed on the tray.
- Do not use any strong cleaning agent or solvent cleaner.
- Use a damp cloth and mild cleaning agent to clean the surface of the appliance.
- Do not use a steam or pressure cleaner to clean the appliance. This will damage the appliance and may create a life-threatening hazard.
- Do not pour water or other liquids into the LANGPAK compartment.
- Keep appliance, LANGPAK containers and accessories out of reach of children.
- This appliance is designed for LANGPAK containers exclusively.
- All Lang Beverages appliances pass stringent controls. Reliability tests under practical

conditions are randomly performed on selected units. Some units can therefore show traces of previous use.

· Lang Beverages reserves the right to change instructions without prior notice.

**WARNING!** LANG purified mineralized water and flavored beverages are fresh produce and do not contain any preservatives. Consume the same day of processing if kept in room temperature, or within 3 days if stored cold (less than +8C / +46F).

Hereby, [LANG Beverages SA] declares that the radio equipment type [C021] is in compliance with Directive 2014/53/EU.

The full text of the EU declaration of conformity is available at the following internet address: [www.drinklang.com](http://www.drinklang.com)

## SHORT CORD INSTRUCTIONS

· Use the power cord supplied with the device in an unmodified form. It is important for user safety that the appliance is only used with a suitably grounded electrical supply.

a) A short power supply cord or detachable power supply cord is to be provided to reduce risks resulting from becoming entangled in or tripping over a longer cord.

b) Extension cords are available and may be used if care is exercised in their use.

c) If a long detachable power cord or extension cord is used:

1) The marked electrical rating or the detachable power cord or extension should be at least as great as the electrical rating of the appliance.

2) The appliance is grounded and only grounded extension cord should be used (type 3-wire cord).

3) The longer cord should be arranged so that it will not dangle over the countertop or tabletop, where it can be pulled on by children or tripped over.

· The appliance has a grounded plug.

· To reduce the risk of electric shock, this plug is intended to fit into a grounded outlet only one way.

· If the plug does not fit fully into the outlet, reverse the plug.

· If it still does not fit, contact a qualified electrician.

· Do not attempt to modify the plug in any way.

## DESCALING

Lang Beverages descaling agent, when used correctly, helps to ensure the proper functioning of your appliance over its life-time and that your drinking experience is as perfect as on the first day. For instructions on how to descale, consult the section “Descaling” in the user manual.

LANG BEVERAGES SA  
BAARERSTRASSE 125,  
6300 ZUG  
SWITZERLAND

MADE IN CHINA

# Index TheWell 2

<b>1. OVERVIEW</b>	<b>6</b>
1.1 Components	
1.2 Control Panel	
<b>2. STARTUP GUIDE</b>	<b>8</b>
2.1 Installing the filters	
2.2 Inserting the LANGPAK containers (minerals and flavors)	
2.3 Connecting the power	
2.4 Installing the jar	
2.5 Selecting the language	
2.6 App Setup	
2.7 Setting the date	
2.8 Setting up the filters	
2.9 Hot cleaning	
<b>3. NORMAL OPERATION</b>	<b>21</b>
3.1 Fill level	
3.2 Cold, hot & flavored water processing	
3.3 Consuming LANGWATER & LANGWATER+	
3.4 Energy saving mode	
<b>4. MENU OPTIONS</b>	<b>24</b>
4.1 Customize	
4.2 Maintenance menu options	
4.3 Setup menu	
<b>5. MAINTENANCE</b>	<b>36</b>
5.1 Cleaning	
5.2 Drip tray	
5.3 Automated maintenance cycles	
5.4 Hot cleaning	
5.5 Changing the filters	
5.6 Descaling	
5.7 Filter rinsing	
<b>6. TROUBLESHOOTING</b>	<b>46</b>
<b>7. PRODUCT INFORMATION</b>	<b>55</b>

# 1. OVERVIEW

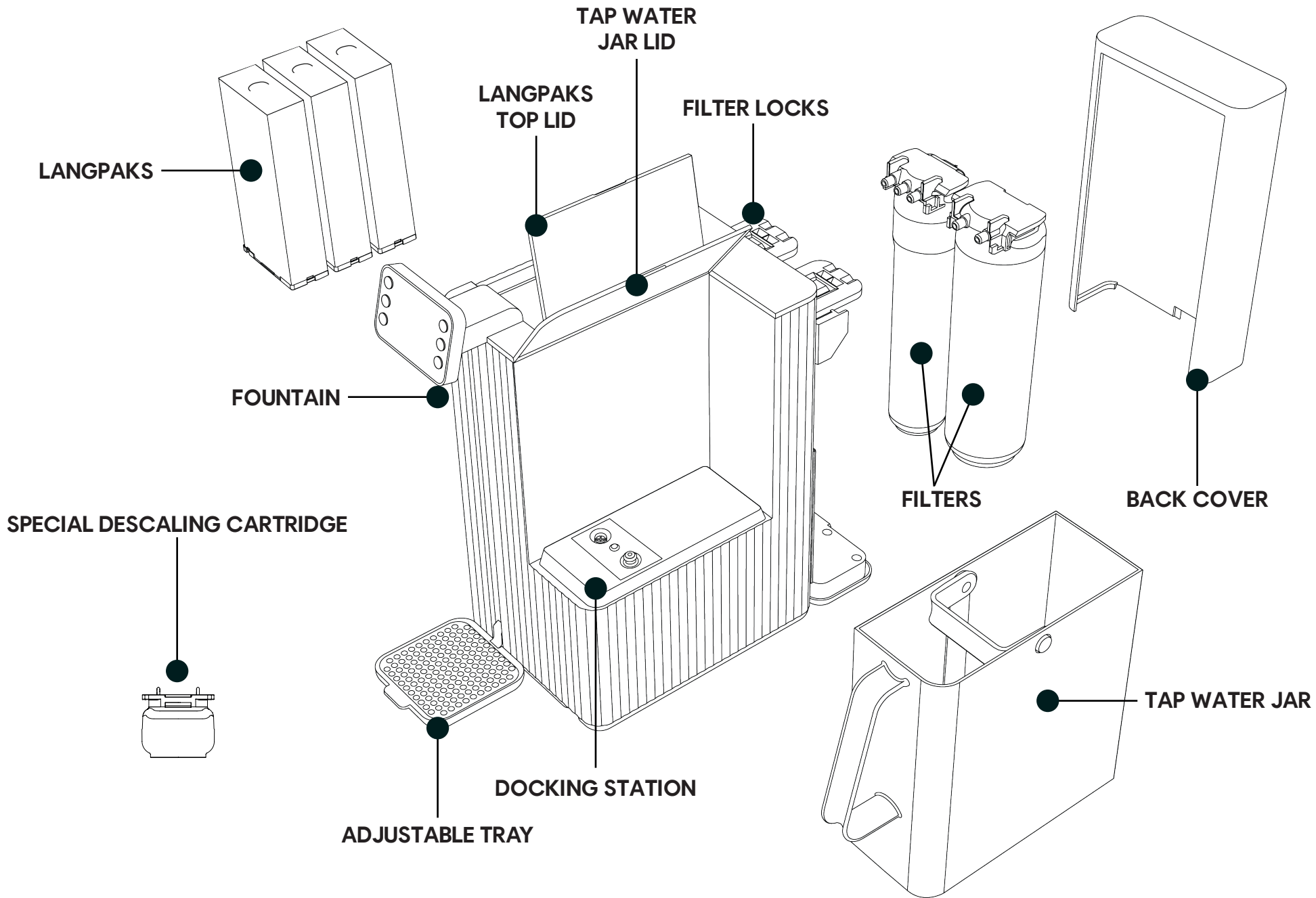

## 1.1 COMPONENTS

This package contains TheWell 2 beverage system with the following accessories:

1 x Tap Water Jar With Lid

2 x Filter Cartridges (Sediment + Activated Carbon, RO Membrane).

1 x Power Cord

1 x Special Descaling Cartridge (SDC)

## 1.2 CONTROL PANEL

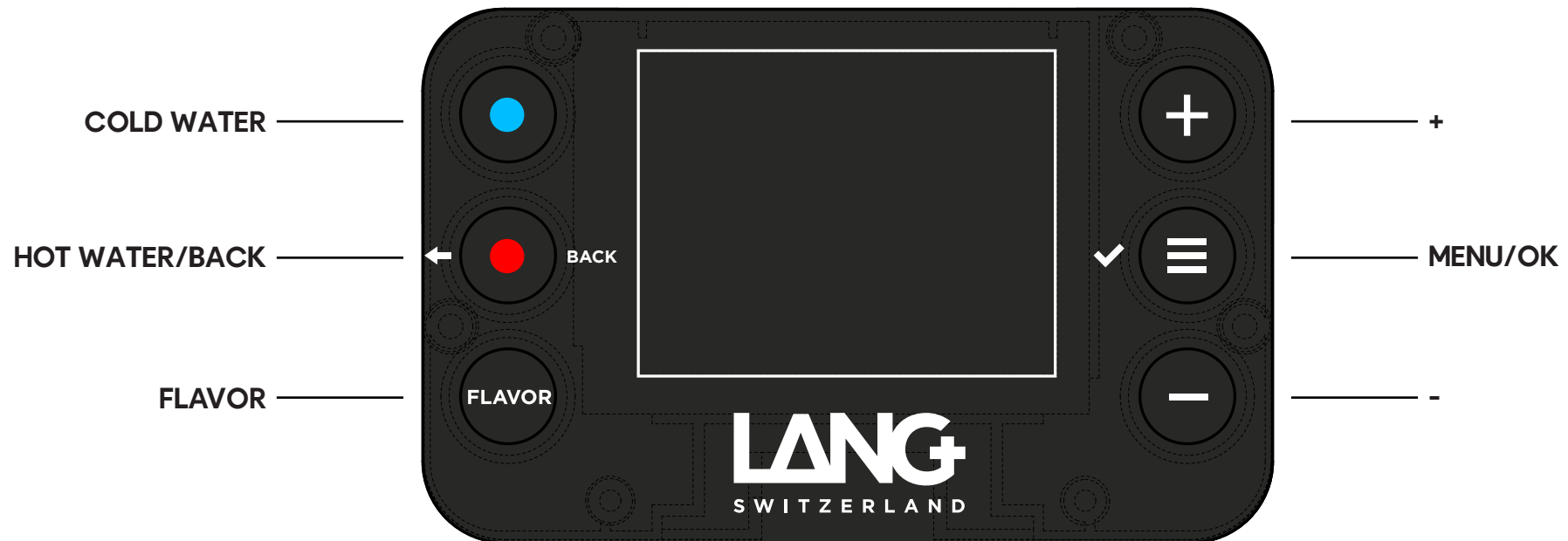

## 2. START-UP GUIDE

Before using TheWell 2 for the first time, you'll need to complete the Setup Process, which takes about 25 minutes. TheWell 2's display will guide you through the steps, and the following section explains them in detail.

### 2.1. INSTALLING THE FILTERS

TheWell 2 system has two filters. Both are required for operation.

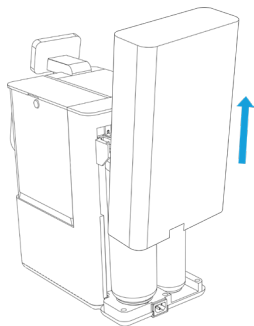

Open the rear cover. Lift up to unlock hooks.

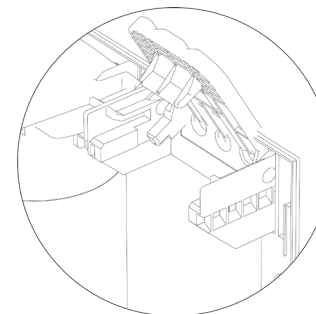

Push the levers up to install filter cartridges.

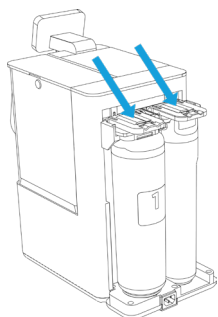

Install the two filter cartridges.  
 1. Sediment + Activated Carbon filter  
 2. RO Membrane

When done, push each lever down until it locks.

Make sure the levers are tightly locked to avoid water spray or leakage.

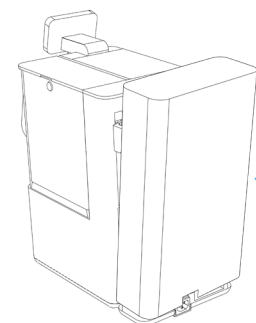

Re-install the rear housing cover.



## 2.2. INSERTING THE LANGPAK CONTAINERS (MINERALS AND FLAVORS)

TheWell 2 has three LANGPAK slots. Two containers are required (Mineral A and Mineral B) and one is optional (flavor).

Install LANGPAK Mineral A in the slot marked “A”.

Install LANGPAK Mineral B in the slot marked “B”.

**IMPORTANT:** TheWell 2 system will only operate when both Mineral A and Mineral B containers are inserted. TheWell 2 will also detect when the mineral containers are empty and will stop operating until they are replaced.

Optional: install a LANGWATER+ flavor container in the slot marked “C”

**IMPORTANT:** Push the containers down until they lock firmly in position.

Close the top lid after minerals and flavor containers are installed.

**IMPORTANT:** If the top lid does not close completely, it means that one or more of the LANGPAK containers are not properly inserted. Remove and reinsert the containers, pushing them down firmly so they lock.

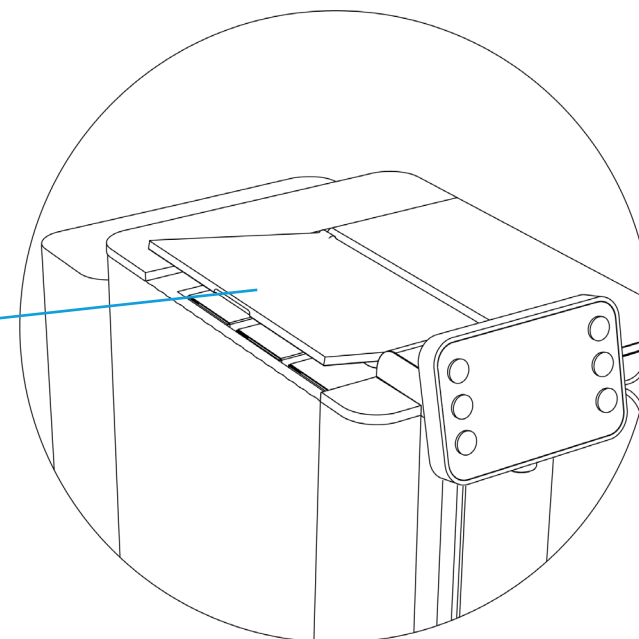
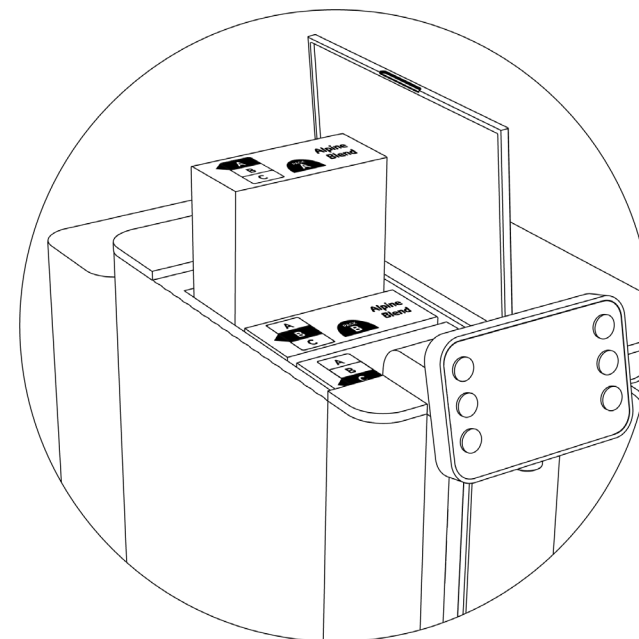

## 2.3 CONNECTING THE POWER

Connect the power cord.  
TheWell 2 will now turn on and display the language selection menu.

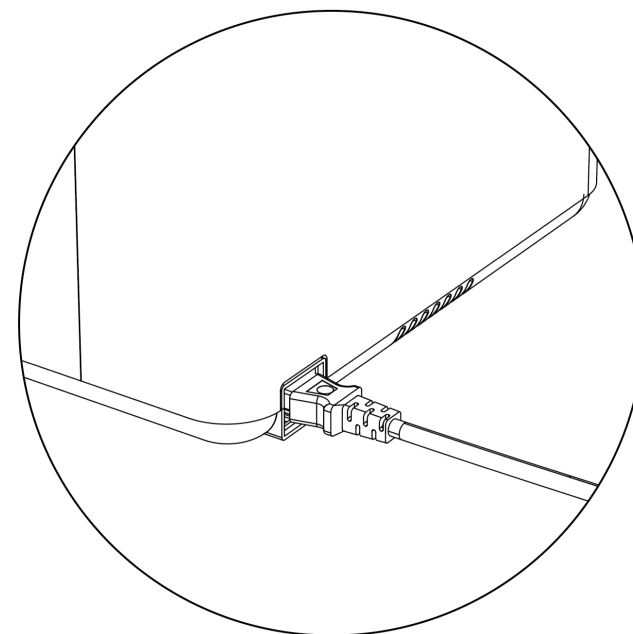

---



## 2.4 INSTALLING THE JAR

1. Fill the Tap Water Jar with water, almost all the way to the top. Close the lid.  
Set the Tap Water Jar in the docking station.

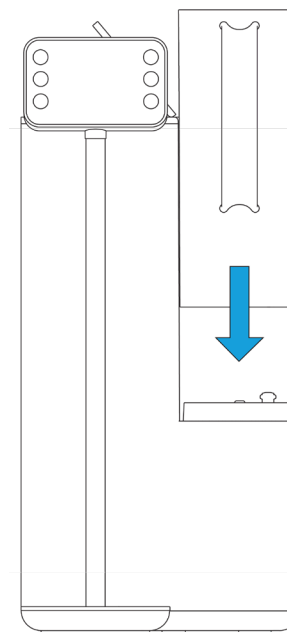
**IMPORTANT:** Be sure that the jar is straight and firmly in position. Otherwise, water may leak. The jar is properly seated if the top lid can be completely closed.



## 2.5 SELECTING THE LANGUAGE

Select the language by using the  and .

Confirm and save your selection by pressing .



## 2.6 APP SETUP

TheWell 2 can be controlled with a companion app. The app can be used to configure the system, to check the status of the LANGPAKs and to buy new LANGPAKs and filters. To use the app, TheWell 2 needs to be connected to a Wi-Fi router with Internet connection.

To use the app, press  to confirm the selection.

If you select no, please continue to chapter 2.7

TheWell 2 will now suggest to download the app for Android and iOS.

Please select the desired option with  and  and confirm with .

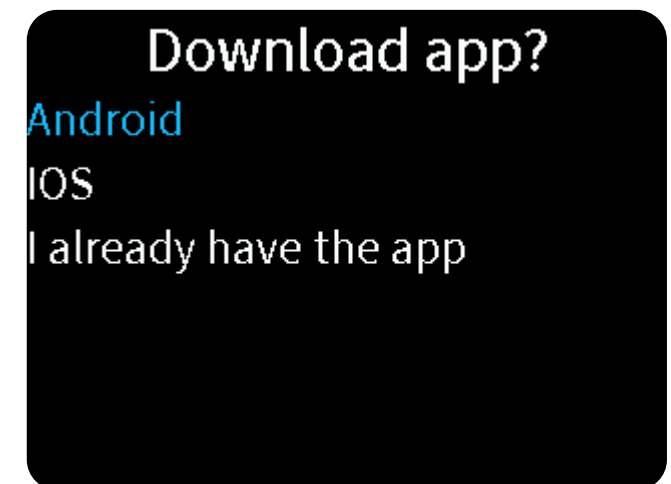

If “Android” or “iOS” have been selected, TheWell 2 will show a QR code with the link to the store. The links are the following:

- Android: [www.drinklang.com/app-android](http://www.drinklang.com/app-android)

- iOS: [www.drinklang.com/app-ios](http://www.drinklang.com/app-ios)



After download  
confirm ✓



After download  
confirm ✓

After downloading the app, press  to confirm.

TheWell 2 will now start the configuration procedure which must be completed with the app. Open the LANG app on the phone and continue the configuration process.

NOTE: if you have more than one system, you can select the system that matches the ID shown on the screen



After the configuration is completed, TheWell 2 will show the following screen.

Press  to continue.



## 2.7 SETTING THE DATE

Set the current date. Use  and  to change the value for day,

month, and year. Press  to cycle through the day, month, and year.

Press  to save the date.

Setting the date allows TheWell 2 to keep track of schedules for cleaning and filter replacement.

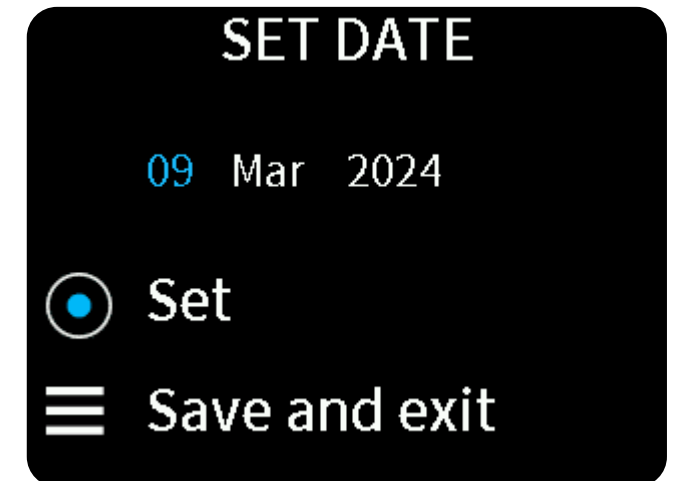

## 2.8 SETTING UP THE FILTERS

When new filters are inserted in TheWell 2, they need to be filled and rinsed before they can be used to process water. Since TheWell 2 comes with new filters, this filter change procedure is required to set it up and takes about 25 minutes. The procedure is automated, but it requires that the user be available to fill the Tap Water Jar with clean water and empty the Clean water container when it is full. This will be required several times during the procedure. The duration of the filters depends on the amount of water processed.

LANG recommends to change filter **1** every 1500 liters or every 12 months (whichever comes first) and filter **2** every 3000 liters or every 24 months (whichever comes first).

TheWell 2 will warn automatically when one or both filters are due for replacement.

**WARNING! DO NOT DRINK THE WATER THAT IS PROCESSED DURING THE CHANGE FILTER PROCESS, SINCE THIS IS ALSO A CLEANING PROCESS.**

Insert all new filter cartridges as described in Section 2.1 above.

Make sure the filters are properly seated, the levers are locked, and the rear cover is in place.





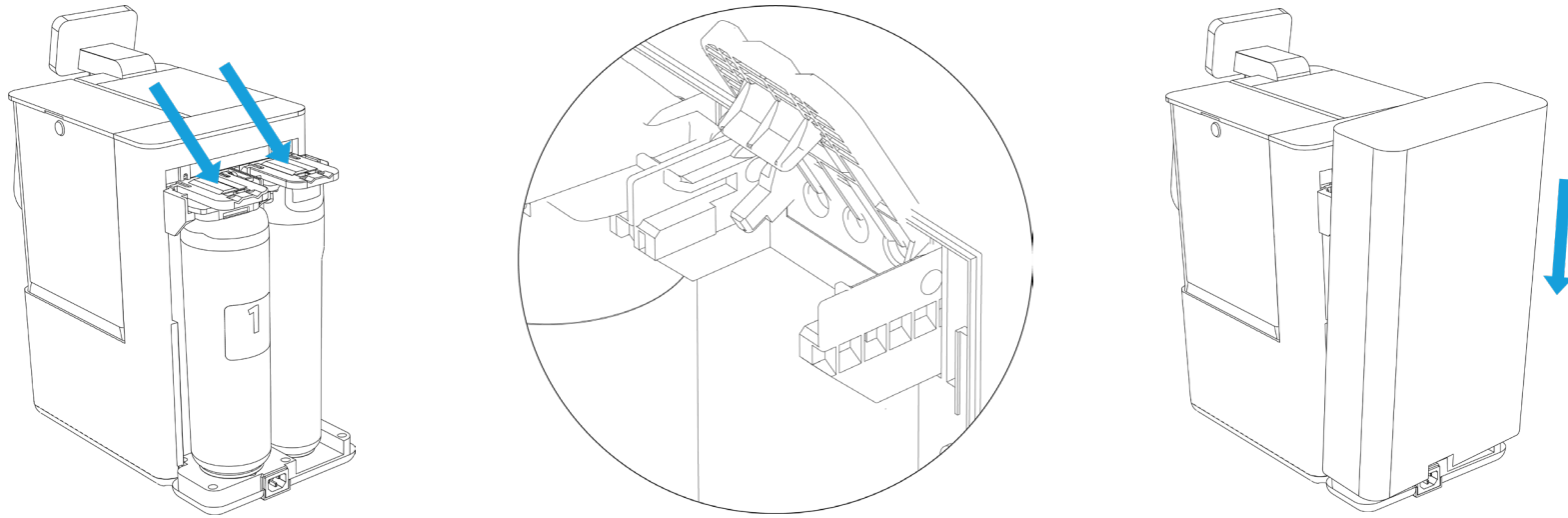

Once the filters are correctly inserted, press  to continue.

TheWell 2 system will now instruct the user to empty and refill the Tap Water Jar. Make sure the Tap Water Jar is filled with fresh water and correctly placed in the docking



TheWell 2 will now instruct the user to empty the Clean water container and place it under the spout.

Once it is correctly inserted, press  to continue.

NOTE: The Clean water container must be able to contain at least 1 liter of water.

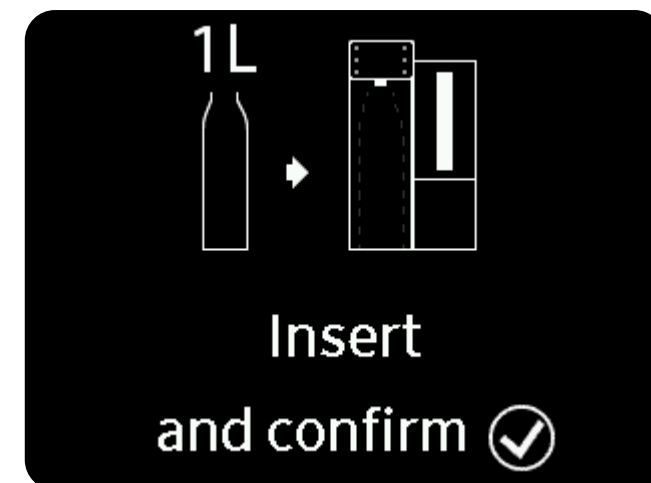

TheWell 2 will now start running water through the new filters. Approximately 4 liters of water will need to be processed before the procedure is finished.

During this process, when the Tap Water Jar becomes empty or the Clean water container becomes full, TheWell 2 will show one of the following two warnings:

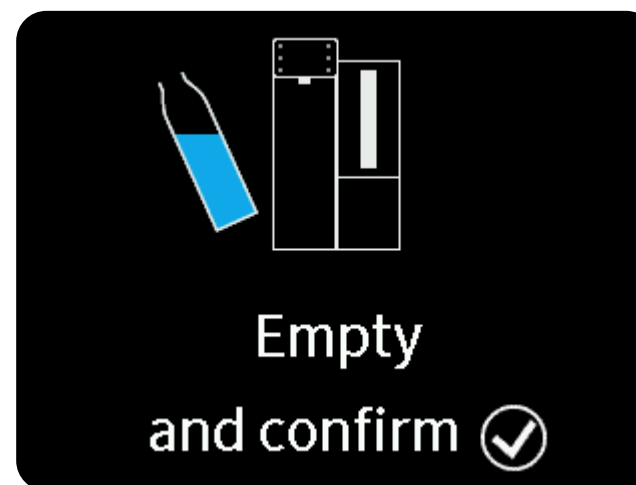

## 2.9 HOT CLEANING

TheWell 2 has an automated cleaning process; it uses the built-in boiler to create hot water to clean and sanitize the components inside the system. The Hot Cleaning Procedure, which takes about 2 minutes, is initiated automatically every day. The automatic interval can be changed, and hot cleaning can also be started manually from the “Maintenance” menu. This ensures that you always get clean and healthy water, no matter how much time has passed since you last used the TheWell 2. The Hot Cleaning Procedure requires the user to do the following:

---

Remove and completely empty the Tap Water Jar.  
Refill the Tap Water Jar and put it into the docking station.

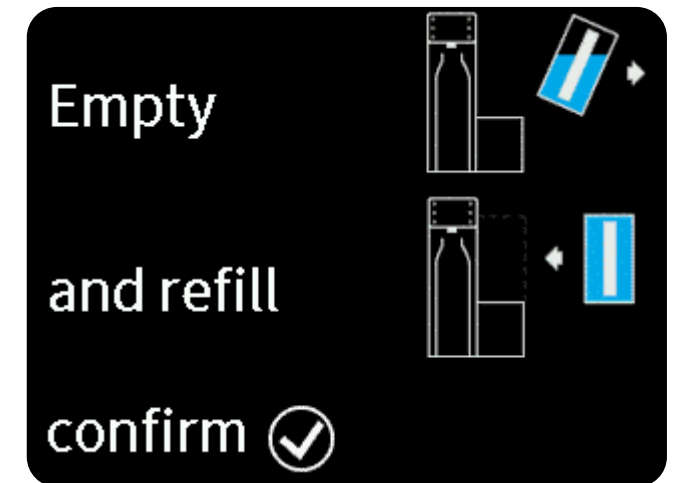

Empty the Clean water container and insert it into the beverage tray.

After inserting it press  to continue.

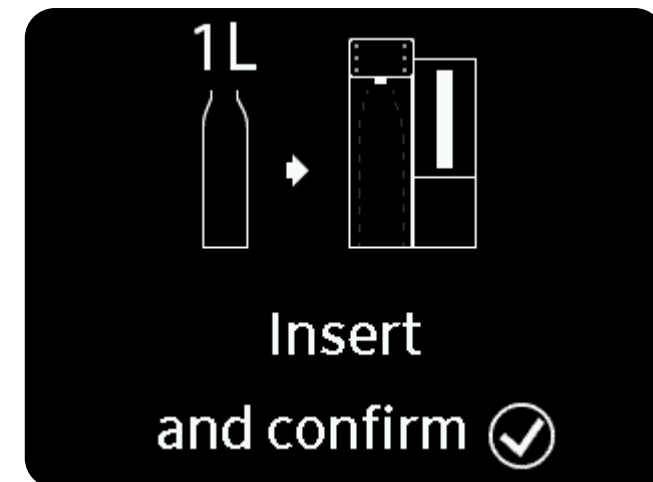

TheWell 2 will now perform the automated Hot Cleaning Procedure.

When finished, empty the Clean water container and confirm by pressing  to complete the process.

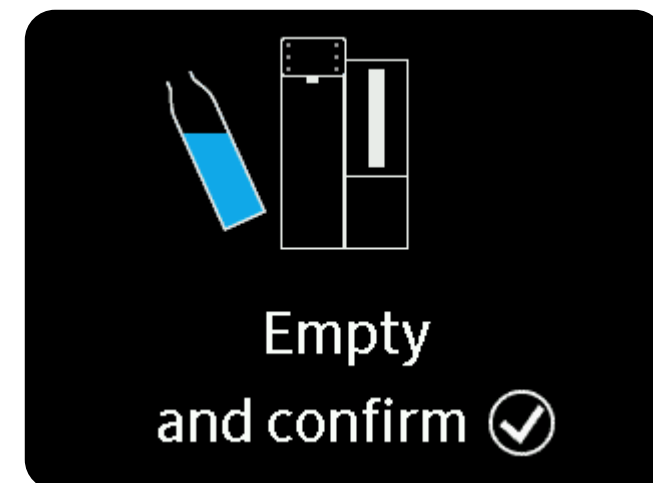

**WARNING! DO NOT DRINK THE WATER THAT IS PROCESSED DURING THE HOT CLEANING PROCESS!**

Once Hot Cleaning has finished, TheWell 2 is ready for use. Section 3, Normal Operation, explains how to use it.

## 3. NORMAL OPERATION



### 3.1 FILL LEVEL

The TheWell 2 system has an intelligent feature to automatically detect the position of the beverage tray. The tray can have three different positions and for each position the desired fill level can be customized. To customize the fill level, move the tray to the required position and press

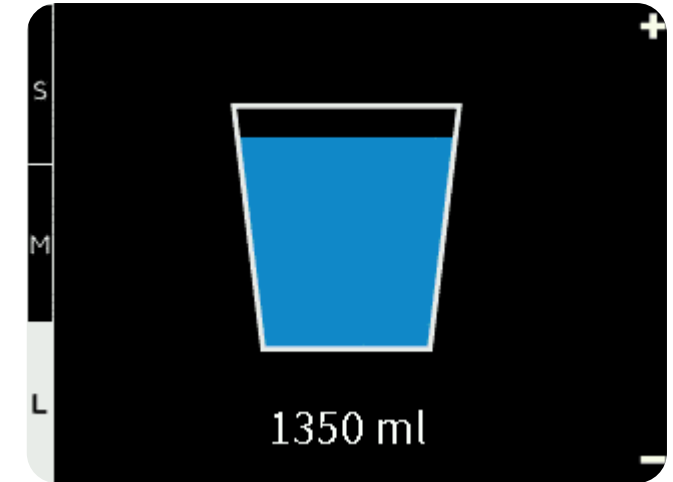
and press  and  to adjust.



### 3.2 COLD, HOT & FLAVORED WATER PROCESSING

1. Turn on TheWell 2 using any of the HOT WATER, COLD WATER or FLAVOR buttons ( , ,  ).
2. Ensure that the Tap Water Jar is filled and inserted into the docking station.

**IMPORTANT:** Always completely empty the Tap Water Jar before refilling it. Never refill the jar while there is still water inside!

3. Adjust the height of the tray for the container that you want to use (bottle, cup, glass) on the tray. TheWell 2 will automatically adjust the fill level to the customized level for that tray position.

4. Place the desired container on the tray

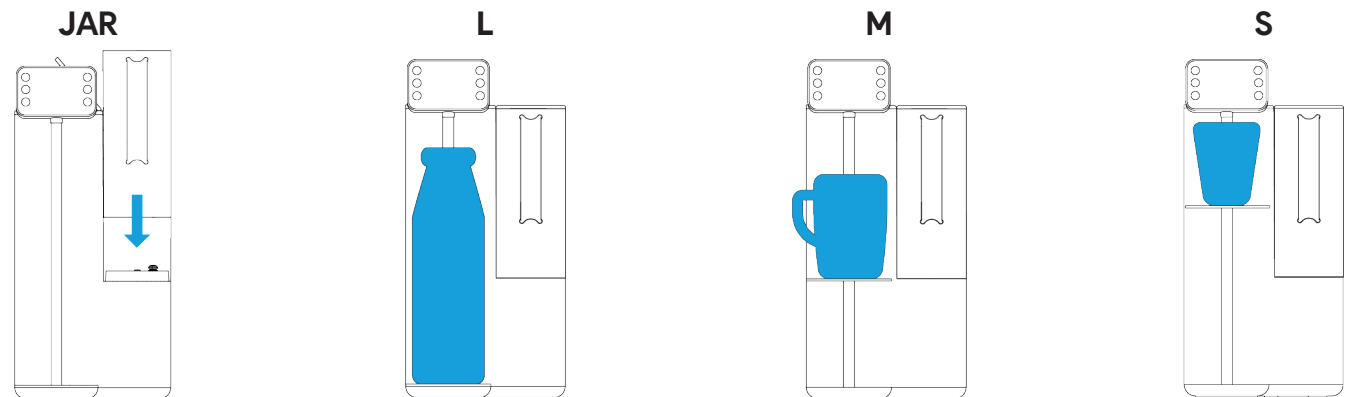

4. Select COLD WATER , HOT WATER , or FLAVOR  to start processing. While TheWell 2 is processing water, the following information will be displayed:

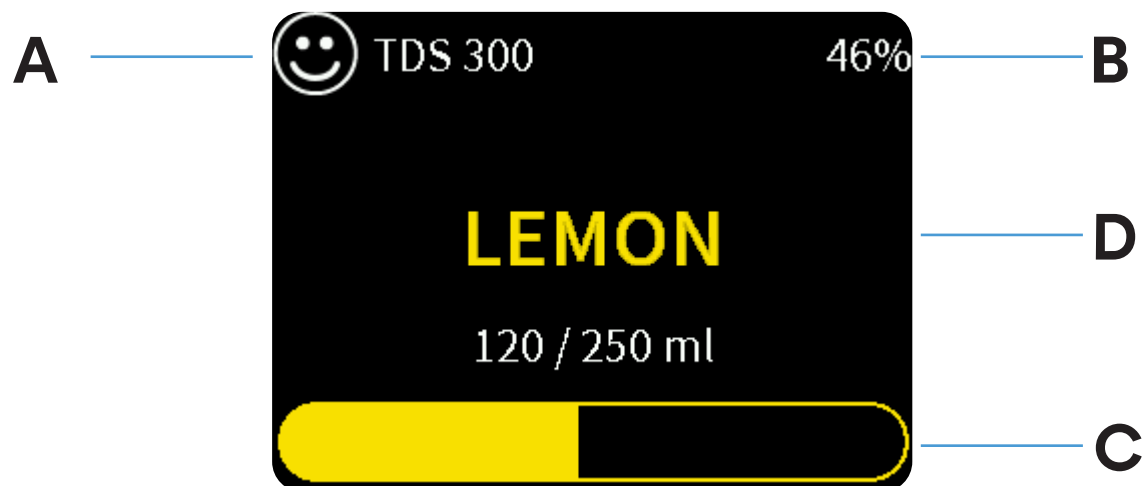

- A) This icon and the number indicate the quality of your tap water. The lower the number, the better the quality.
- B) The percentage of flavor concentrate left in the LANGWATER+ container, when processing FLAVOR.
- C) The amount of volume TheWell 2 has already processed and the total amount selected.
- D) The name of the LANGWATER+ flavor, when processing FLAVOR.



**IMPORTANT:** You can only select FLAVOR  if a LANGWATER+ container is correctly inserted in LANGPAK Slot C.

When a LANGWATER+ container is inserted, the logo of the flavor content will be displayed. TheWell 2 will automatically determine if it is a cold (e.g., fruit flavor) or a hot (e.g., tea) beverage and will serve it with the correct temperature and amount of flavor. Minerals are also added when a flavor is processed.

After preparing a flavored serving, TheWell 2 will display “Finishing” while automatically rinsing the fountain with pure water to make sure that the next serving will not have any residual flavor taste.



Finishing

5. TheWell 2 will automatically stop processing once the desired fill level is reached (see Section 3.1), or you can manually stop it by pressing the selected button again. (  ,  ,  ) .



**WARNING: HOT WATER/HOT SURFACE**

### 3.3 CONSUMING LANGWATER & LANGWATER+

**WARNING! LANG** purified mineralized water and flavored beverages are completely fresh and do not contain any preservatives. At room temperature, beverages should be consumed the same day, or within three days if refrigerated (less than +8C / 46F).



Always ensure that the Tap Water Jar and Clean water container used when processing fresh LANGWATER and LANGWATER+ beverages do not contain any old water or flavored drinks, and that they are properly washed between use.

## 3.4 ENERGY SAVING MODE

TheWell 2 has a Stand-by feature that turns TheWell 2 off automatically to save energy. If TheWell 2 is on Standby, you can turn it on using any of the HOT WATER, COLD WATER or FLAVOR buttons (  ,  ,  ).

## 4. MENU OPTIONS

To enter the configuration menu, press  while TheWell 2 is in Standby Mode.

Use  and  to scroll through the options and press  to enter/confirm.

While in one of the menus, press  to return to the previous menu.

To exit the configuration menu, press  while on the main setup menu.

### 4.1 CUSTOMIZE

TheWell 2 settings can be customized, saving your personal preferences for volume, taste, and temperature of water and beverages.

Select Customize in the  and choose from the following settings:

**Customize**  
 Hot water temperature  
 Flavor temperature  
 Flavor intensity  
 Mineral intensity



## HOT WATER TEMPERATURE

From this menu item, you can select the desired temperature for hot water processing.

### Hot water temperature

70 °C

75 °C

80 °C

85 °C

90 °C

---

## FLAVOR TEMPERATURE

From this menu item, you can customize the temperature of hot flavored drinks. We have already selected the optimal serving temperature for LANGWATER+ flavored drinks, but you can adjust this temperature to your taste.

IMPORTANT: this setting does not affect the temperature of cold flavored drinks.

### Flavor temperature

- 10 °C

- 5 °C

Normal

+ 5 °C

+ 10 °C

## FLAVOR INTENSITY

From this menu item, you can customize the intensity of flavored drinks. We have already selected the optimal concentration for LANGWATER+ flavored drinks, but you can use this menu to make them more or less intense.

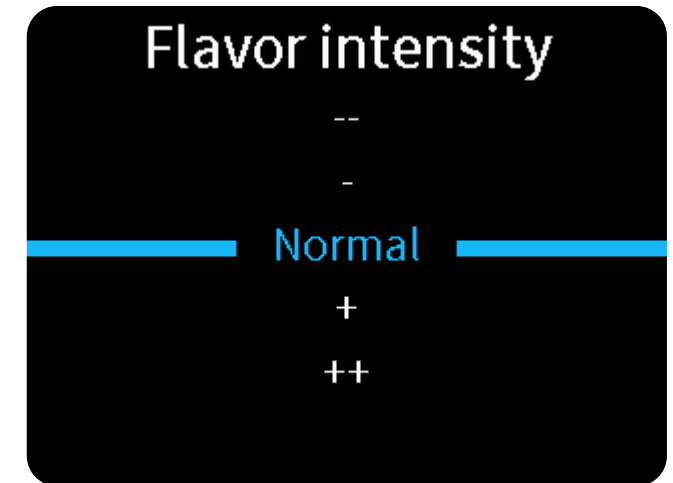

---

## MINERAL INTENSITY

From this menu item, you can customize the mineralization strength of the water. The default setting (Normal) has the optimal intensity for a neutral taste, but you can increase or decrease the amount of minerals added to the purified water.

**IMPORTANT:** it is not possible for the water to be completely mineral-free. It would be unhealthy and negatively affect the taste.

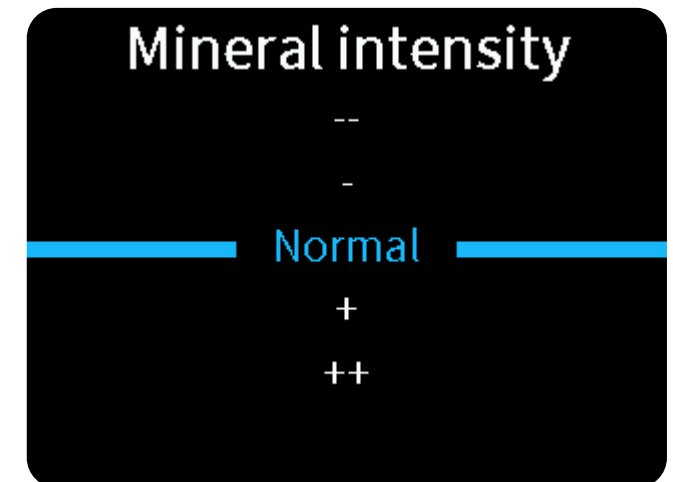

## 4.2 MAINTENANCE MENU OPTIONS

Most maintenance functions of the TheWell 2 are automated, but they can also be started manually. The Maintenance menu allows you to begin processes that include hot cleaning, descaling, and changing the filters. You can also customize the schedules for some of the automated maintenance processes.

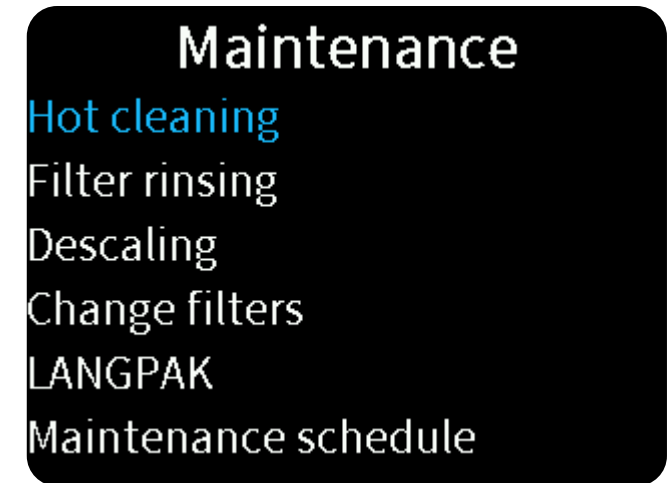

---

## HOT CLEANING

Choose “Hot cleaning” and then press Yes to start the Hot Cleaning Procedure, described in Section 2.9.



## FILTER RINSING

Choose “Filter rinsing” and then press Yes to start the Filter Rinsing Procedure, described in section 5.7.

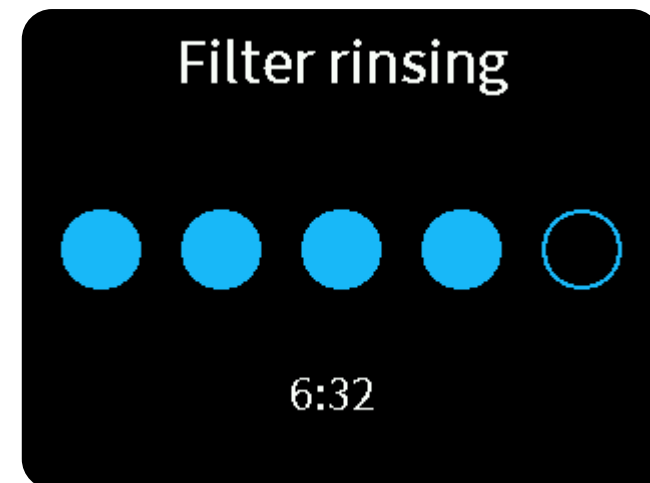

---

## DESCALING

Choose Descaling and then press Yes to start the Descaling Procedure, described in Section 5.5.

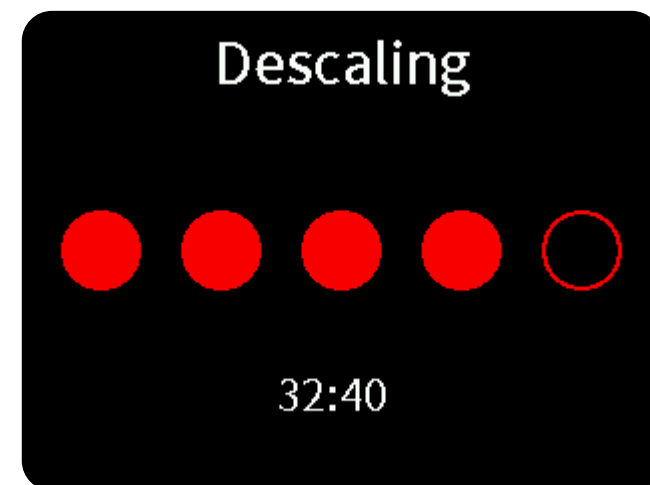

## CHANGE FILTERS

Before starting the procedure, select which filter you want to change.  
Choose Change filters and then press Yes to begin the process of changing the filters, described in Section 2.8.

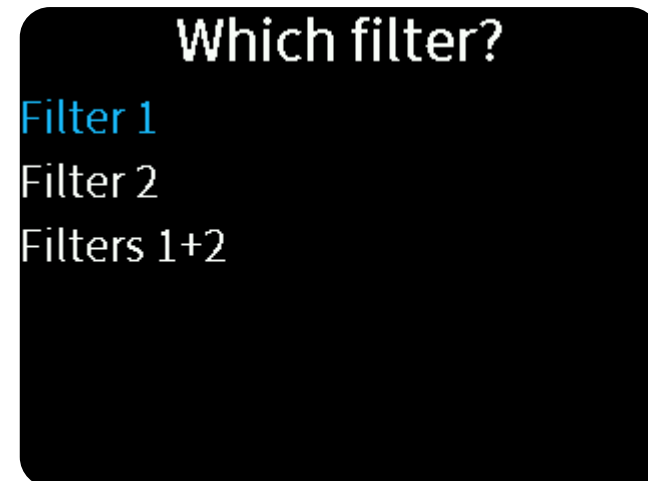

## LANGPAK

Choose "LANGPAK" to check the status of your LANGPAKs.



## MAINTENANCE SCHEDULE

From this menu item, you can check to see when the filters need to be replaced. This allows you to order them in advance. It also displays the next scheduled hot cleaning cycle.

### Maintenance schedule

Current date	09 Dec 2024
Hot cleaning	10 Dec 2024
Change filter 1	09 Jun 2025
Change filter 2	09 Dec 2026

## HOT CLEANING INTERVAL

From this menu item, you can customize the interval between hot cleaning cycles. We recommend hot cleaning every day.

### Hot cleaning interval

Off

Every day

Every 2 days

## 4.3 SETUP MENU

Select Setup in the Menu to access the following settings:

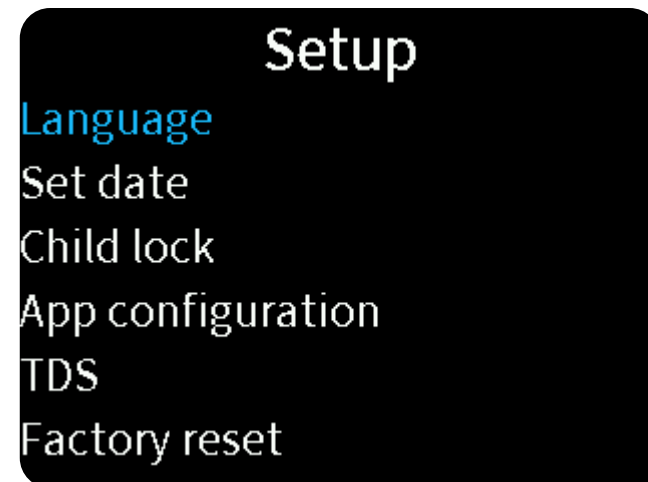

---

## LANGUAGE

From this menu item, you can change the user interface language, as described in Section 2.4.



## SET DATE

From this menu item, you can change the current date of TheWell 2, as described in Section 2.7.

If TheWell 2 has not been connected to power for a long time, it will prompt you to update the date.

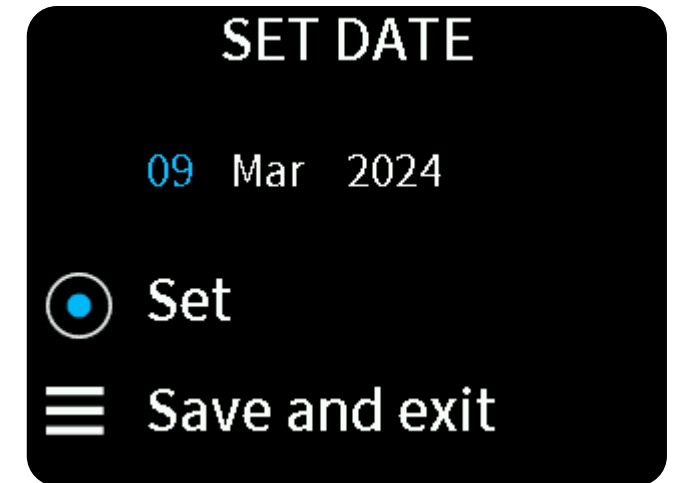





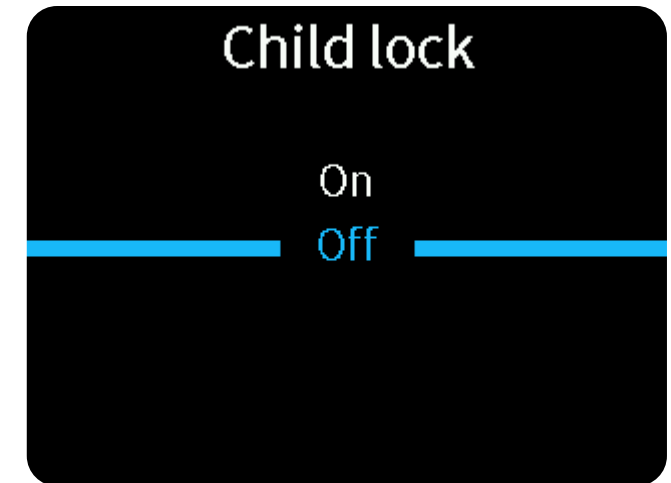

## CHILD LOCK

TheWell 2 system has an optional safety feature that prevents children from processing hot water without the help of an adult.



If Child Lock is enabled, when Hot Water  or hot Flavors  are selected TheWell 2 will display



To temporarily disable the child lock and process Hot Water  or hot Flavors  press  for 3 seconds until TheWell 2 shows:



The Child Lock feature will remain disabled until TheWell 2 system goes into standby.

## APP CONFIGURATION

TheWell 2 system has a companion app that gives access to additional features, like buying LANGPAKS, checking the system health and so on.

If TheWell 2 was not connected to Internet during the setup phase (2.5) or if the system needs to be reconfigured, enter this menu.

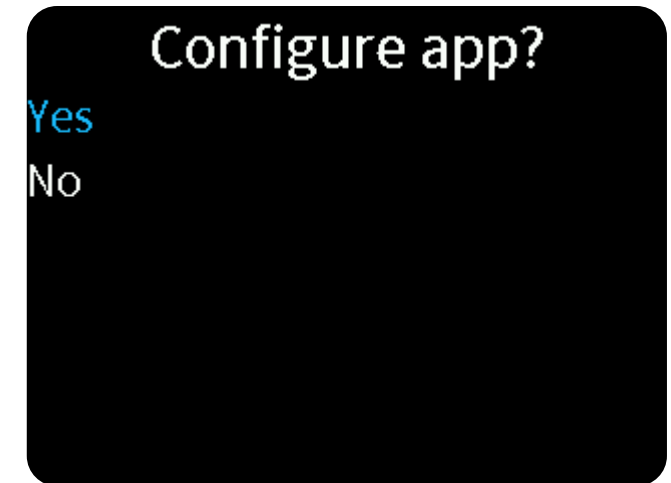

---

## TDS

TheWell 2 has a sensor to detect the quality of the tap water. As the water gets purified during the processing, the water in the tap water jar will start accumulating the particles and ions that are filtered out of the clean water.

TheWell 2 will monitor the quality of the water and display an icon on the screen.

To disable the TDS reading, select "Off" and confirm.

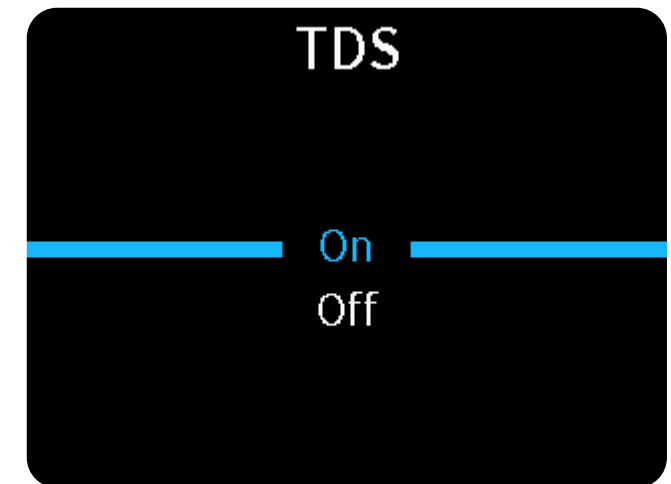

## FACTORY RESET

This function can be used to restore TheWell 2 to the factory state.

IMPORTANT: You will lose all your customizations if you perform this procedure.

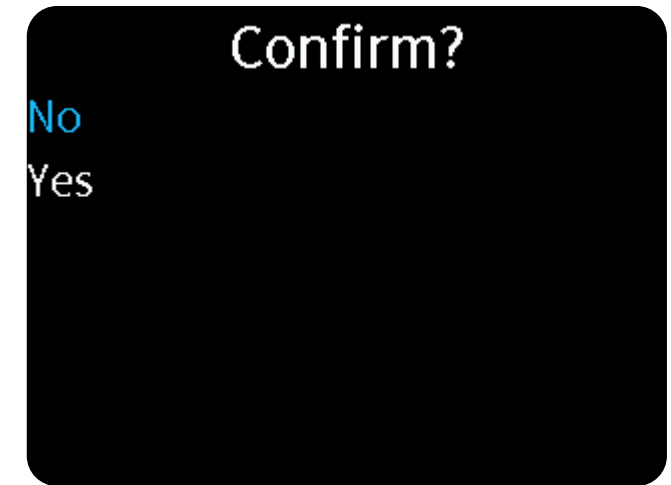

---

## FIRMWARE VERSION

This menu item is used to check the version of firmware installed in TheWell 2.

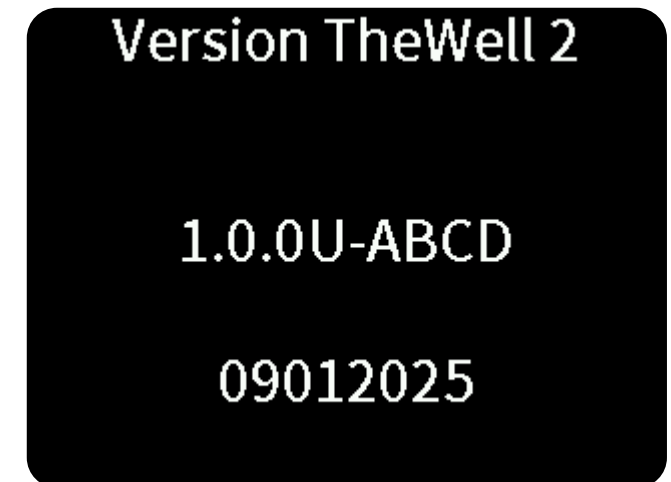

## 5. MAINTENANCE

### 5.1 CLEANING

Always wash the jar thoroughly before using them. The jar is dishwasher-safe, so you can wash it together with other dishes. You can also wash them with warm water and soap.

All the plastic parts on TheWell 2 system's exterior can be cleaned with warm water and soap. Avoid pouring water into the LANGPAK compartment. Use a damp cloth to clean it.

---

### 5.2 DRIP TRAY

TheWell 2 comes with a tray on the left to collect the evaporation that forms while processing hot water. Empty and clean the tray regularly.

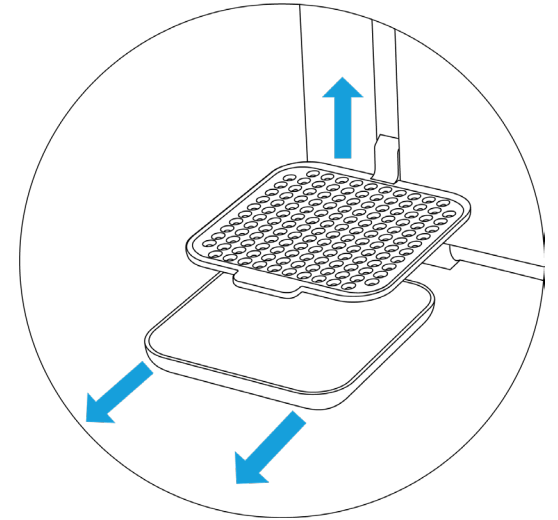

### 5.3 AUTOMATED MAINTENANCE CYCLES

TheWell 2 features automated maintenance procedures that ensure hassle-free optimal performance.

## 5.4 HOT CLEANING

Hot Cleaning is an automated process that uses the built-in boiler to create hot water to clean and sanitize the components inside TheWell 2. The Hot Cleaning Procedure, which takes about 2 minutes, is initiated automatically every day. The automatic interval can be changed, and hot cleaning can also be started manually from the “Maintenance” menu. This ensures that you always get clean and healthy water, no matter how much time has passed since you last used the TheWell 2.

**The Hot Cleaning Procedure is described in detail in Section 2.9 of Setup.**

---

## 5.5 CHANGING THE FILTERS

The duration of the filters depends on the amount of water processed.

LANG recommends to change filter **1** every 1500 liters or every 12 months (whichever comes first) and filter **2** every 3000 liters or every 24 months (whichever comes first).

TheWell 2 will warn automatically when one or both filters are due for replacement.

When new filters are inserted in TheWell 2 system, they need to be filled and rinsed before they can be used to process water. The procedure is automated, but it takes about 25 minutes, and it requires that the user be available to fill the Tap Water Jar with clean water and empty the Clean water container when it is full.

**The Setting Up Filters Procedure is described in detail in Section 2.8 of Setup.**

The duration of filter **2** is also affected by the quality of the tap water. If tap water is particularly hard, the duration may decrease significantly.

The recommended duration (24 months or 3000 liters) can only be guaranteed by doing regular descalings.

---

## 5.6 DESCALING

Depending on the hardness of your tap water, calcium deposits may form inside TheWell 2. Over time, these calcium deposits may reduce the performance of TheWell 2 and the filters and potentially reduce their lifespan. If you notice that TheWell 2 is operating more slowly, calcium deposits may already have formed inside. To remove the calcium deposits, TheWell 2 has an automated Descaling Procedure, which requires the two Special Descaling Cartridges (SDC) included with TheWell 2, as well as 50 grams of citric acid.

TheWell 2 will automatically show a warning when a descaling is needed (see page 50).

**IMPORTANT:** To ensure the best duration possible for your filters, we recommend you execute this procedure every 2 months or every 300 liters, even if you are not sure about the hardness of your tap water or you know it is not hard. TheWell 2 will warn you when 300 liters have been processed and a descaling is needed.

Begin the Descaling Procedure by going into the “Maintenance menu” and selecting “Descaling.”

## Maintenance

Hot cleaning

Filter rinsing

Descaling

Change filters

LANGPAK

Maintenance schedule

Replace Filter Cartridge 1 with the Special Descaling Cartridge (SDC) that came with TheWell 2 system.

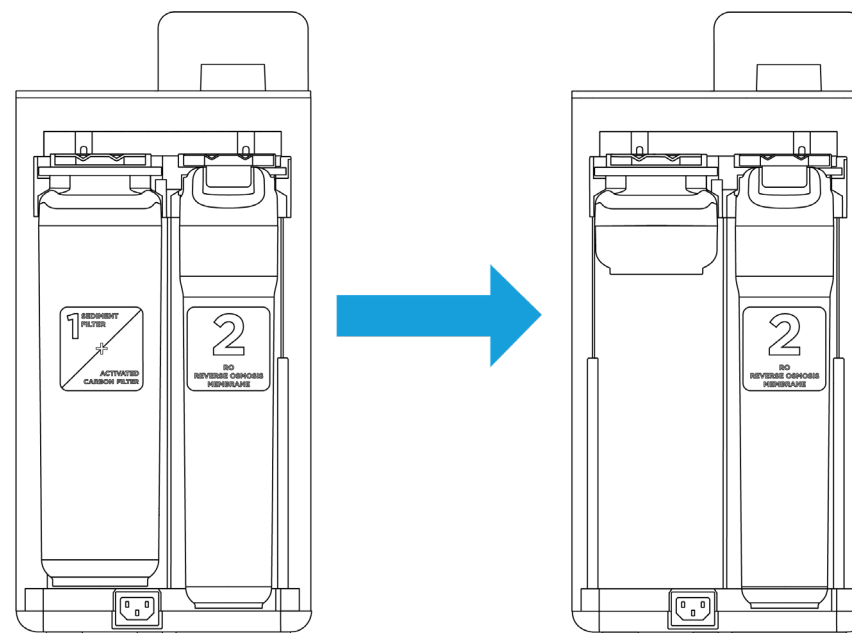

Make sure to lock the latch in place. Press  to continue.

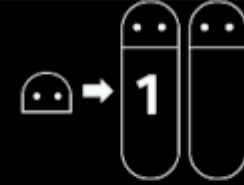

Replace filter 1  
with SDC  
and confirm 

The system will prompt you to empty and refill the Tap Water Jar.  
Ensure the jar is completely filled and correctly inserted in the docking station.

Empty



and refill

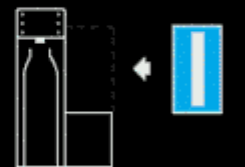

confirm 

After the Tap Water Jar is properly inserted, the system will prompt you to empty and place the Clean water container into the beverage tray.

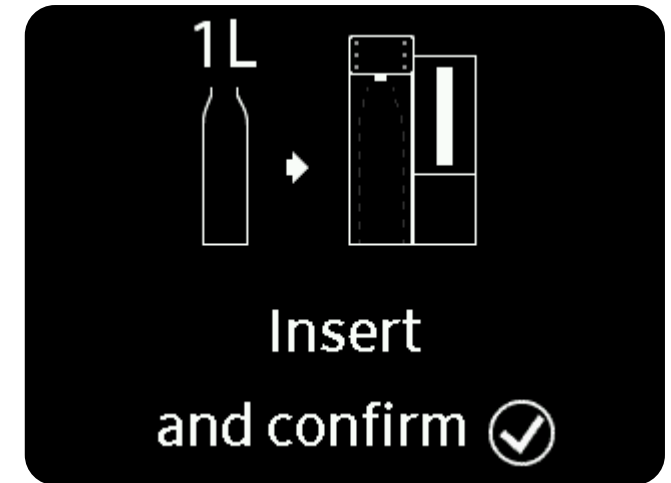

Add 50 grams (10 tablespoons) of citric acid to the Tap Water Jar. Citric acid can be found in many local grocery stores or supermarkets. There is no need to stir after you have added the additive to the Tap Water Jar.

Once you have measured and added it, press  to continue.

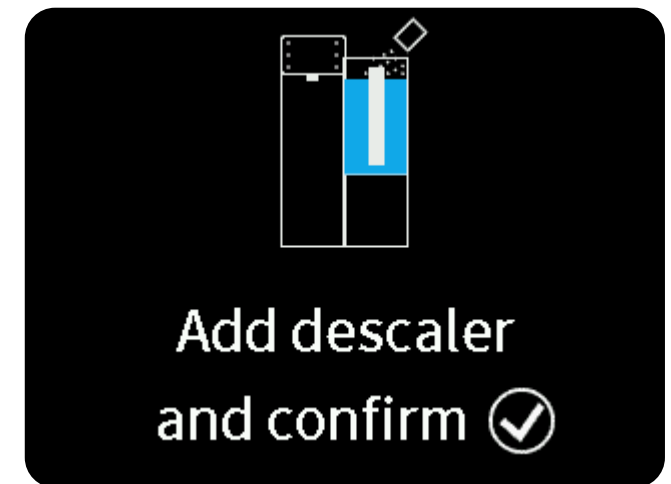

TheWell 2 will now start the automated Descaling Procedure, which takes about 25 minutes. The time remaining until completion will be displayed on the screen.

**WARNING! DO NOT TURN OFF THE POWER DURING THIS PROCEDURE.**



Once the automated procedure is finished, replace the Special Descaling Cartridge (SDC) with the original filter cartridge.



TheWell 2 will now flush the internal pipes with approximately 2 liters of water to remove all the descaling agent.  
Empty and refill the Tap Water Jar and place it in the docking station.

**IMPORTANT:** Be sure to empty the Tap Water Jar completely before refilling.

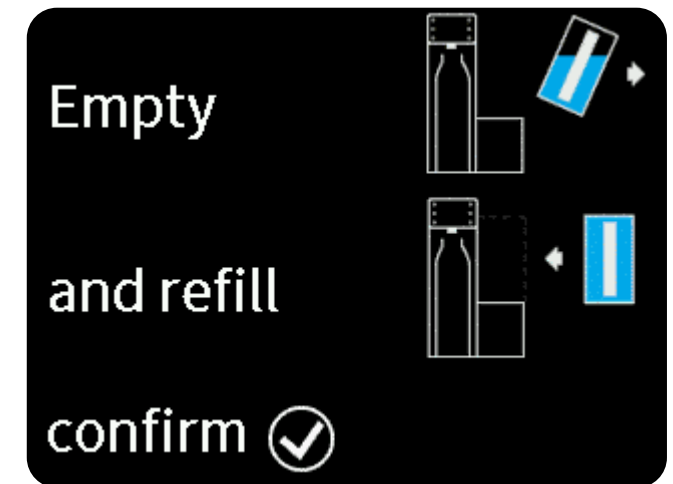

TheWell 2 will now ask you to place an empty Clean water container on the tray.

Insert the jar and press  to continue.

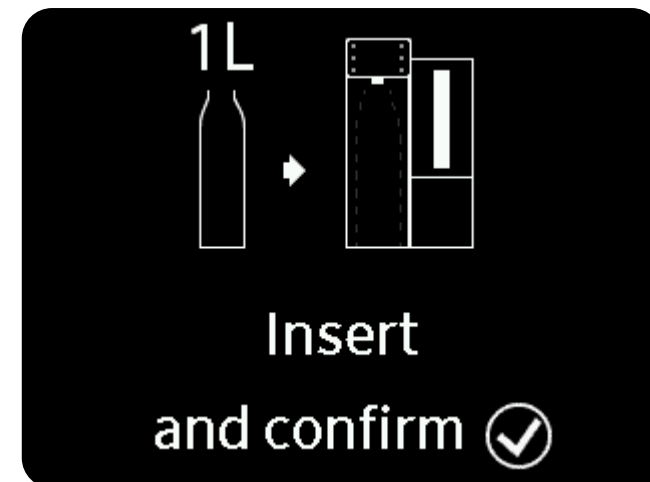

TheWell 2 will now process one liter of water.  
Once it has finished one liter, it will ask you to empty and refill the Tap Water Jar and place it in the docking station.

**IMPORTANT:** Be sure to empty the Tap Water Jar completely before refilling.

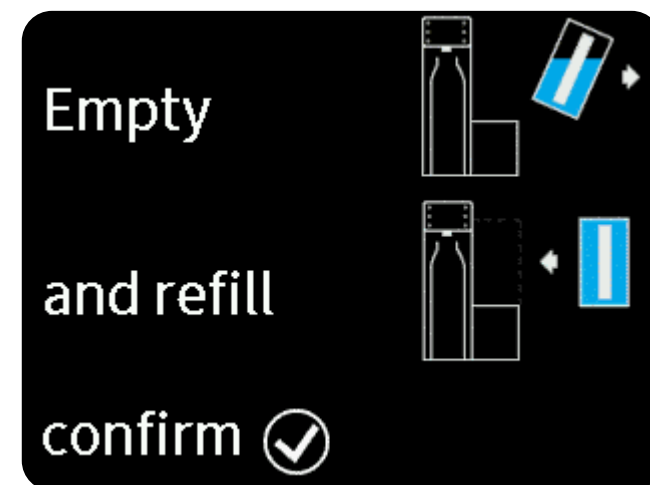

TheWell 2 will now ask you to place an empty Clean water container in the beverage tray. Insert the container and press  to continue.

TheWell 2 will now process the second liter of water.

---

TheWell 2 has now been cleaned and the Descaling Procedure finished.

**IMPORTANT:** After the Descaling Procedure, the clean water may have a hint of lemon flavor. This is perfectly fine and comes from the natural descaling additive, which is not harmful for your health. If you want to remove any residual lemon flavor, process another liter of water.

Descaling

finished

## 5.7 FILTER RINSING

The Filter Rinsing procedure can be used to do a deep cleaning and/or a disinfection of the filters. TheWell 2 will ask the user to empty and refill the tap water jar with clean water and let water run at high speed through the filters to remove all sediments that may have formed over time. Optionally, Hydrogen Peroxide (a common disinfectant) can be added to the water to disinfect the filters.

As a first step, TheWell 2 will ask to empty the tap water jar. TheWell 2 will then ask the user to refill the tap water jar. If a disinfection of the filters must be performed, 125 ml of 3% hydrogen peroxide can be added inside the tap water. Stirring is not needed.

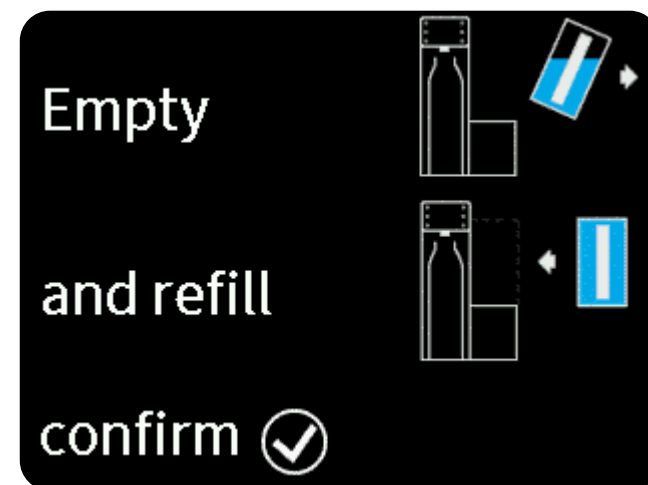

TheWell 2 will then ask to insert the clean water container and press  to confirm.

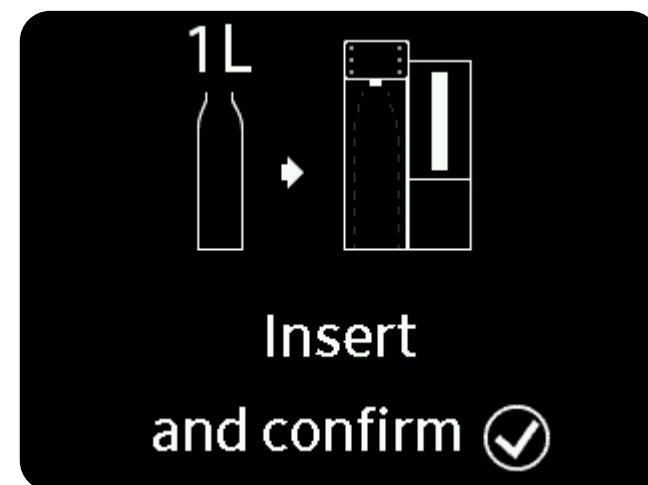

TheWell 2 will then start rinsing the filters for approximately 6 minutes.

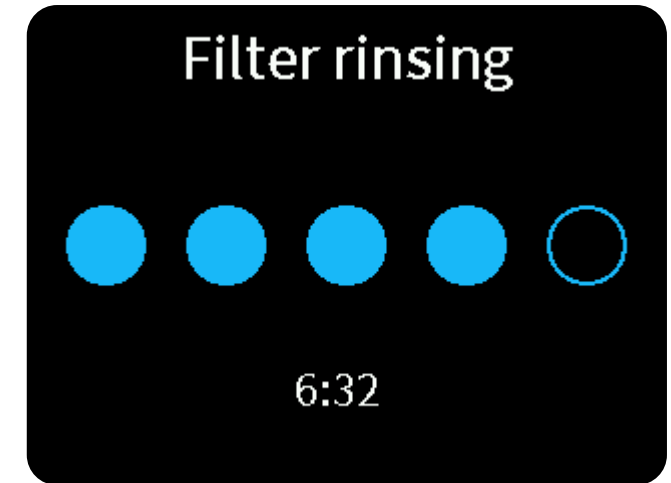

After the rinsing procedure has finished, TheWell 2 will ask to empty the clean water container and press  to confirm

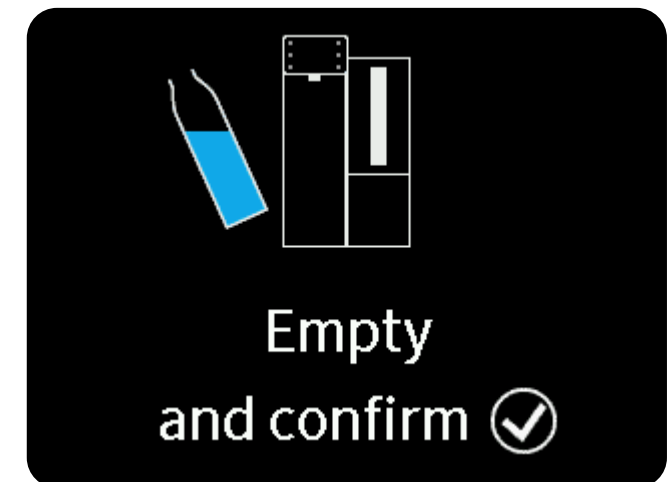

The tap water jar must then be emptied and refilled with clean water.

**WARNING:** Do not drink the water from the Filter Rinsing procedure.

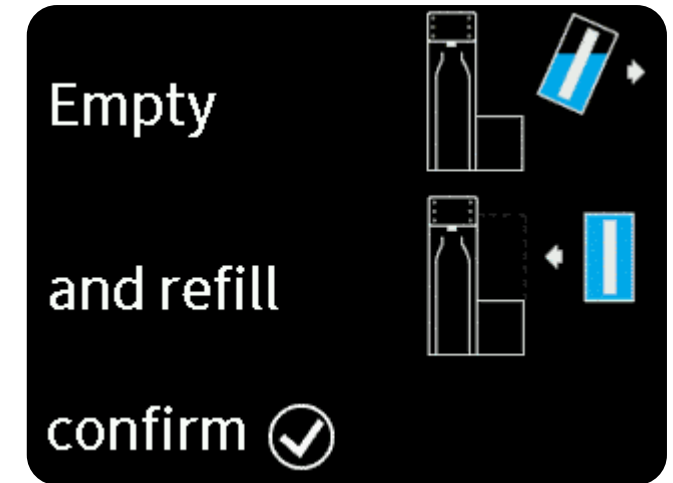

## 6. TROUBLESHOOTING

Refer to this section if you experience problems during processing or use.

### IF THE SYSTEM DOES NOT TURN ON

Make sure the power cable is correctly attached and there is power at the outlet. Press any button to turn on TheWell 2. If it fails to turn on, contact LANG Technical Support.

### WATER LEAKAGE

Make sure the Tap Water Jar is correctly positioned (see Section 2.5). If the leakage persists, contact Lang Technical Support.

### SYSTEM OPERATES SLOWLY

There may be calcium deposits inside TheWell 2 system. Perform a Descaling Procedure (see Section 5.6 under Maintenance).

## CLEAN WATER CONTAINER FULL

TheWell 2 has finished processing water and the drink is ready.

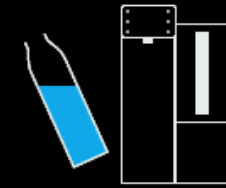

Empty  
and confirm ✓

## FLAVOR EMPTY

The LANGWATER+ flavor container is empty and needs to be replaced.

LEMON

empty

## MINERAL MISSING

The LANGPAK mineral containers are missing or not inserted correctly. Remove and re-insert. Make sure the lid closes completely.

**IMPORTANT:** TheWell 2 will only operate when both Mineral A and Mineral B containers are inserted. TheWell 2 will also detect when the containers are empty and will stop operating until replaced. LANGPAK Mineral A and Mineral B containers are always changed together.

Minerals

missing

## LOW MINERALS

The LANGPAK mineral containers are almost empty.  
Order new ones from [www.drinklang.com](http://www.drinklang.com) before you run out.

## DAMAGED FILTER CHANGE

TheWell 2 has a sensor that can detect the functionality of the RO filter.  
If the filter is not performing correctly, TheWell 2 will show this warning.  
Please contact LANG Technical support.

## MINERALS EMPTY

The LANGPAK mineral containers are empty and need to be replaced. TheWell 2 will only operate when both Mineral A and Mineral B containers are inserted. TheWell 2 will also detect when the containers are empty and will stop operating until replaced.

IMPORTANT: LANGPAK Mineral A and Mineral B containers are always changed together.

Low  
minerals

Damaged  
filter 2  
change

Minerals  
empty



## LANGPAK ERROR

You have inserted the wrong type of LANGPAK container (e.g., two flavor containers or two Mineral A containers). The three slots must have one Mineral A, one Mineral B, and one optional flavor. You can only insert one flavor at a time.

**LANGPAK**

**Error**

## HIGH WATER TEMPERATURE

The filters are designed to operate with water temperatures in the range 5 °C - 35 °C. The water in the tap water jar is too hot and it will reduce the life of the filters. Please replace it with cold tap water.

**High water**

**Temperature**

## CHANGE FILTERS

TheWell 2 will automatically notify when filters must be replaced. When you see this warning, order new filters from [www.drinklang.com](http://www.drinklang.com) and replace them as soon as possible. The real duration of the filter cartridges may change depending on the usage and the water quality.

**Change**

**filters 1+2**

## LOW FLOW RATE

The performance of TheWell 2 can be influenced by a number of factors, including the quality and temperature of the tap water, the age of the filters and limescale build up. TheWell 2 can automatically detect when the performance has degraded substantially and will show the “Low flow rate” warning. If the warning is persistent, please try the following:

- remember to always empty the tap water jar before refilling it. This makes sure the filters will last for their entire specified life.
- perform a descaling of TheWell 2 (see Section 5.6 Descaling)
- if the filters are more than 6 months old, replace the filter set
- if nothing works, contact LANG Technical Support

## DESCALING NEEDED

Scaling will impact the performance of TheWell 2, significantly increasing the amount of time needed for a serving. To prevent this, the user should perform regular descaling procedures with citric acid. TheWell 2 will automatically show a warning when a descaling is needed (every 300 liters). To remove the warning, perform a descaling (see 5.6 DESCALING)

## ERROR 1 FLOW METER

Contact LANG Technical Support.

**Low  
flow rate**

**Descaling  
needed**

**Error  
1  
Flow meter**

## ERROR 3 FLASH

Contact LANG Technical Support.

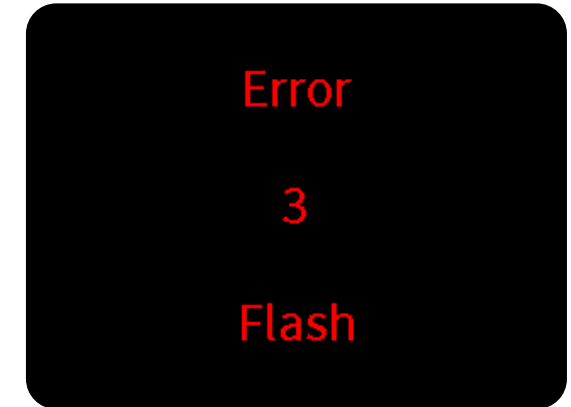

## ERROR 4 LOW FLOW RATE

This may happen if there are calcium deposits inside TheWell 2 system. Perform a descaling procedure (see Section 5.5). If the calcium deposits were particularly strong, you may also have to replace the filters.

If the problem persists, contact LANG Technical Support.

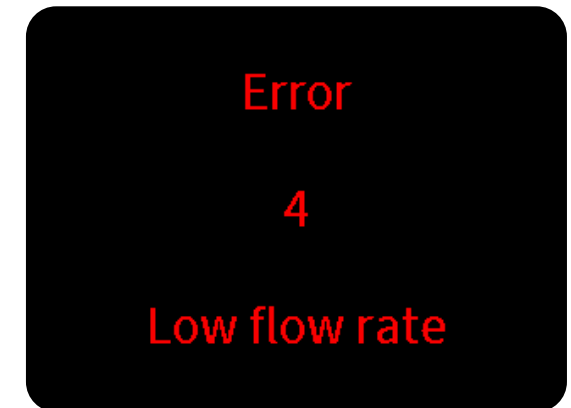

## ERROR 5 DOSING STATION

This may occur if the LANGPAK containers have not been used for a long time. Remove the power cable and clean the LANGPAK compartment inside TheWell 2 with a damp, soapy cloth. Wipe off any soap residue with a damp cloth. Then remove the LANGPAK containers, shake them vigorously, and reinsert them into TheWell 2. If the problem persists, contact LANG Technical Support.

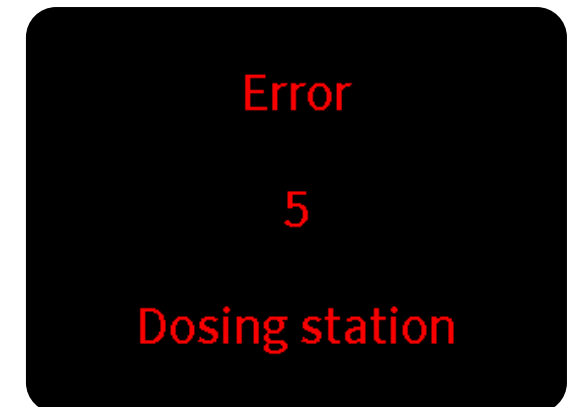

## ERROR 6 LOW TEMPERATURE

TheWell 2 cannot reach the desired hot water temperature.  
Remove the power cable, wait one minute, then plug it in again.  
If the problem persists, contact LANG Technical Support.

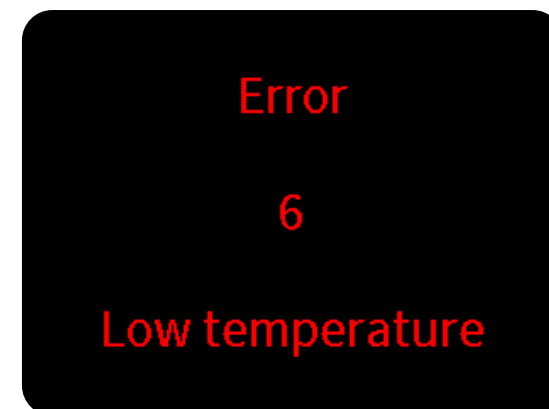

## ERROR 7 HIGH TEMPERATURE

Remove the power cable, wait one minute, then plug it in again.  
If the problem persists, contact LANG Technical Support.

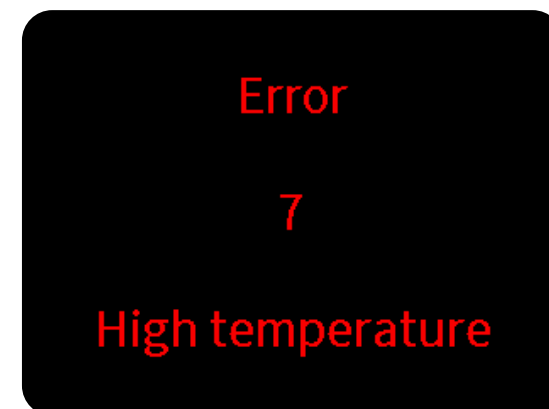

## ERROR 8 LANGPAK NFC

Remove the power cable, wait one minute, then plug it in again.  
If the problem persists, contact LANG Technical Support.



## ERROR 10 DOSING STATION

Remove the power cable, wait one minute, then plug it in again.  
If the problem persists, contact LANG Technical Support.

## ERROR 11 TDS SENSOR

Remove the power cable, wait one minute, then plug it in again.  
If the problem persists, contact LANG Technical Support.

## ERROR 12 INTERNET CONNECTIVITY

Remove the power cable, wait one minute, then plug it in again.  
If the problem persists, contact LANG Technical Support.

Error  
10  
Dosing station

Error  
11  
TDS sensor

Error  
12  
Connectivity

## ERROR 14 MEMORY

Remove the power cable, wait one minute, then plug it in again.  
If the problem persists, contact LANG Technical Support.

Error

14

Memory

## 7. PRODUCT INFORMATION

Model: C020, C021

Temperature operating range: 10 - 35 °C  
Tap water temperature range: 5 - 35 °C

US Ratings:

**RATINGS**  
**120 Vac/60Hz**  
**1600W/Class I**

EU Ratings:

**RATINGS: 230 Vac**  
**50-60Hz, 800W, Class I**  
**Max. Input: 1600W**

EU (C020) distributor: LANG Beverages SA  
Address: Baarerstrasse 125, 6300 Zug, Switzerland

Manufacturer: LANG Beverages SA  
Address: Baarerstrasse 125, 6300 Zug, Switzerland

Please respect local regulations: dispose of any non-functional electrical equipment at an appropriate waste disposal center.

Wireless specification:

2.4G WIFI transmitter frequency range:  
2412 MHz - 2472 MHz (EU)/2412 MHz - 2462 MHz (US)  
2.4G WIFI transmitter power: <20 dBm (EIRP)

RFID transmit frequency: 13.56MHz  
RFID radiated maximum field strength:  $\leq 42$  dB $\mu$ A/m at 10 m

Bluetooth transmitter frequency range:  
2402 MHz - 2480 MHz  
Bluetooth transmitter power:  $\leq 10$  dBm (EIRP)

## ENVIRONMENT-FRIENDLY DISPOSAL



You can help protect the environment!

# LANG TheWell 2

[WWW.DRINKLANG.COM](http://WWW.DRINKLANG.COM)